

RoHS 2 Compliant

iServer



User's Guide

Shop on line at

omega.com[®]

Ω OMEGA[®]

omega.com
e-mail: info@omega.com

iSeries info:
omega.com/specs/iseries
For latest product manuals
omegamannual.info



**Embedded Ethernet for iSeries
Monitor/Controller
-C4EIT/-EIT**



OMEGAnet® Online Service
omega.com

Internet e-mail
info@omega.com

Servicing North America:

U.S.A.: OMEGA Engineering, Inc., One Omega Drive, P.O. Box 4047
ISO 9001 Certified Stamford, CT 06907-0047 USA
Toll Free: 1-800-826-6342 TEL: (203) 359-1660
FAX: (203) 359-7700 e-mail: info@omega.com

Canada: 976 Berar
Laval (Quebec), H7L 5A1, Canada
Toll-Free: 1-800-826-6342 TEL: (514) 856-6928
FAX: (514) 856-6886 e-mail: info@omega.ca

For immediate technical or application assistance:

U.S.A. and Canada: Sales Service: 1-800-826-6342 / 1-800-TC-OMEGA®
Customer Service: 1-800-622-2378 / 1-800-622-BEST®
Engineering Service: 1-800-872-9436 / 1-800-USA-WHEN®

**Mexico/
Latin America:** TEL: 001 (203) 359-1660 FAX: 001 (203) 359-7700
e-mail: espanol@omega.com

Servicing Asia:

China: 1698 Yi Shan Road, Unit 102
Min Hang District
Shanghai, China 201103 P.R.C.
Hotline: 800 819 0559 / 400 619 0559
e-mail: info@cn.omega.com

Servicing Europe:

Benelux: Toll-Free: 0800 099 3344 TEL: +31 20 347 21 21
FAX: +31 20 643 46 43 e-mail: sales@omegageng.nl

Czech Republic: Frystatska 184
733 01 Karviná, Czech Republic
TEL: +420-59-6311899 FAX: +420-59-6311114
e-mail: info@omegashop.cz

France: Toll-Free: 0805 541 038 TEL: 01 57 32 48 17
FAX: 01 57 32 48 18 e-mail: esales@omega.fr

Germany/ Austria: Daimlerstrasse 26
D-75392 Deckenpfronn, Germany
Toll-Free: 0800 8266342 TEL: +49 (0) 7056 9398-0
FAX: +49 (0) 7056 9398-29 e-mail: info@omega.de

United Kingdom: OMEGA Engineering Ltd.
ISO 9001 Certified One Omega Drive, River Bend Technology Centre, Northbank
Irlam, Manchester M44 5BD United Kingdom
Toll-Free: 0800-488-488 TEL: +44 (0) 161 777-6611
FAX: +44 (0) 161 777-6622 e-mail: sales@omega.co.uk

It is the policy of OMEGA Engineering, Inc. to comply with all worldwide safety and EMC/EMI regulations that apply. OMEGA is constantly pursuing certification of its products to the European New Approach Directives. OMEGA will add the CE mark to every appropriate device upon certification.

The information contained in this document is believed to be correct, but OMEGA accepts no liability for any errors it contains, and reserves the right to alter specifications without notice.

WARNING: These products are not designed for use in, and should not be used for, human applications.

TABLE OF CONTENTS

Part 1: Introduction	2
1.1 Safety and EMC Considerations	2
1.2 Description	3
Part 2: Hardware	4
2.1 Physical Characteristics and Mounting	4
2.2 Rear Panel of iSeries Meter with Embedded Ethernet Server	5
2.3 Serial Communication Interfaces (For Models with RS485 Port)	5
2.3.1 Wiring RS485 Interface	6
2.4 Network Communication Interfaces	7
2.4.1 10BASE-T RJ-45 Pinout	7
2.4.2 Connecting iServer to PC/Hub/Switch/Router	7
Part 3: Network Configuration	8
3.1 Network Protocols	8
3.2 Ethernet (MAC) Address	8
3.3 DHCP	9
3.4 DNS	9
3.5 IP Address	9
3.6 TCP Port (Socket) Number	10
Part 4: Operations	11
4.1 Serial Interface Configuration-Communication Protocol	11
4.2 Command Structure	11
4.3 Command Formats	11
4.4 Default IP Address	13
4.5 Access and Configuration Using a Web Browser	14
4.5.1 Overview	15
4.5.2 Network	16
4.5.3 Serial (RS485 Serial Port)	18
4.5.3.1 RS485 Serial Port	18
4.5.3.2 Network-to-Serial	19
4.5.3.3 Packing Techniques	20
4.5.3.4 Multi-Host Connection	21
4.5.4 Configuration	22
4.5.4.1 Date and Time	23
4.5.5 Management	24
4.5.5.1 Management - Email SNMP	25
4.5.5.2 Management - Alarm	26
4.5.5.2.1 Sending Txt Messages to a Cell Phone	27
4.5.6 Security	28
4.5.7 Device Query	29
4.5.8 Device Setup	30
4.5.8.1 Device Parameters -C4EIT	31
4.5.8.2 Device Setup -EIT	32

4.5.8.3 Device Parameters -EIT	33
4.5.9 Readings.....	34
4.5.9.1 Readings - Device Setpoints	34
4.5.10 Terminal	35
4.5.11 System	36
4.5.12 Diagnostics	37
4.5.12.1 Diagnostics - Serial Port	37
4.5.12.2 Diagnostics - Ethernet Port	38
4.5.12.3 Diagnostics - Ping	38
 Part 5: Specifications	 39
 Part 6: Factory Preset Values	 41
 Part 7: Approvals Information	 42
 Appendix A Glossary	 43
 Appendix B IP Address	 44
 Appendix C IP Netmask	 45
 Appendix D ASCII Chart	 46
ASCII Chart Control Codes	47
 Appendix E iConnect Software	 48
 Appendix F HTTPget Program	 50
 Appendix G ARP Program.....	 52
 Appendix H Telnet Setup.....	 53
 Appendix I Remote Access (Tunneling).....	 56
 Appendix J iPORT	 61
 Appendix K iLog Software	 65

LIST OF FIGURES:

Figure 1.1 Accessing Devices Over the Ethernet	3
Figure 2.1 Rear Panel View of i16, i8 and iDR Series Meters with Embedded Ethernet Server	4
Figure 2.2 Multi-point, Half-Duplex RS485 Wiring	6
Figure 2.3 RJ-45 Pinout.....	7
Figure 3.1 i8 Labeling	8
Figure 3.2 iDR Labeling	8

Figure 3.3	i16 Labeling	8
Figure 4.1	Pinging the iServer from a DOS Prompt.....	13
Figure 4.2	iServer LOGIN Page.....	14
Figure 4.3	iServer LOGIN and ADMINISTRATOR Passwords	14
Figure 4.4a	iServer -C4EIT OVERVIEW Page	15
Figure 4.4b	iServer -EIT OVERVIEW Page.....	15
Figure 4.5	iServer NETWORK Page	16
Figure 4.6	iServer SERIAL Page – RS485 Serial Port.....	18
Figure 4.7	iServer SERIAL Page – Network to Serial	19
Figure 4.8	iServer SERIAL Page – Packing Techniques	20
Figure 4.9	iServer SERIAL Page – Multi-Host Connection.....	21
Figure 4.10	iServer CONFIGURATION Page – Ethernet Configuration.....	22
Figure 4.11	iServer MANAGEMENT Page – Email, SNMP	24
Figure 4.12	iServer MANAGEMENT Page – Alarm.....	26
Figure 4.13	iServer SECURITY Page	28
Figure 4.14	iServer DEVICE QUERY Page	29
Figure 4.15	iServer DEVICE SETUP Page – RS485 (-C4EIT).....	30
Figure 4.16	iServer DEVICE PARAMETERS Page (-C4EIT	31
Figure 4.17	iServer DEVICE SETUP Page (-EIT)	32
Figure 4.18	iServer DEVICE PARAMETERS Page (-EIT).....	33
Figure 4.19	iServer READINGS Page (-C4EIT)	34
Figure 4.20	iServer DEVICE SETPOINTS Page	34
Figure 4.21	iServer TERMINAL Page.....	35
Figure 4.22	iServer SYSTEM Page	36
Figure 4.23	iServer DIAGNOSTICS Page	37
Figure E-1	Assigning an IP Address using iConnect	48
Figure E-2	Accessing the iServer’s HOME Page	49
Figure F-1	ARP Commands and Responses	51
Figure G-1	ARP Commands and Responses	52
Figure H-1	Tera Term Telnet Connection Screen	53
Figure H-2	Telnet Setup - iServer Configuration Page	53
Figure H-3	Telnet Setup - iServer Help Page	54
Figure I-1a	Serial Tunneling	56
Figure I-1b	Serial Tunneling - Embedded PCB iServer.....	56
Figure I-2	Device-to-Device Communication.....	57
Figure I-3	SERIAL - Multi-Host Connection (-C4EIT)	59
Figure J-1	Direct Serial Connection	61
Figure J-2a	Redirect Serial Connection.....	62
Figure J-2b	Redirect Serial Connection - Embedded PCB iServer	62
Figure J-3	iPORT Main Window	63
Figure J-4	COM Port Window	63
Figure K-1	iLog Software Logging Data for an iSeries	65

LIST OF TABLES:

Table 2.1	Rear Panel Annunciators	5
Table 2.2	Data Transmission Characteristics RS485	5
Table 2.3	Half Duplex Hookup	6
Table 4.1	Command Prefix Letters	11
Table 4.2	Command Formats	11
Table K-1	iLog Excel Applications	66
Table K-2	iLog Error Messages	67

NOTES, WARNINGS and CAUTIONS

Information that is especially important to note is identified by following labels:

- **NOTE**
- **WARNING or CAUTION**
- **IMPORTANT**
- **TIP**

 **Note** ES

NOTE: Provides you with information that is important to successfully setup and use the iServer.



CAUTION or WARNING: Tells you about the risk of electrical shock.



CAUTION, WARNING or IMPORTANT: Tells you of circumstances or practices that can affect the instrument's functionality and must refer to accompanying documents.

 **Tip** ES

TIP: Provides you helpful hints.

Before You Begin

Inspecting Your Shipment: Remove the packing slip and verify that you have received everything listed. Inspect the container and equipment for signs of damage as soon as you receive the shipment. Note any evidence of rough handling in transit. Immediately report any damage to the shipping agent. The carrier will not honor damage claims unless all shipping material is saved for inspection. After examining and removing the contents, save the packing material and carton in the event reshipment is necessary.

Customer Service: If you need assistance, please contact the Customer Service Department nearest you.

Manuals, Software: The latest Operation Manual as well as free configuration software (iConnect), and datalogging software (iLog) are available at **the website listed on the cover page of this manual.**

PART 1 INTRODUCTION

1.1 Safety and EMC Considerations



This device is marked with the international caution symbol. It is important to read this manual before installing or commissioning this device as it contains important information relating to Safety and EMC (Electromagnetic Compatibility).

This instrument is a panel mount device protected in accordance with EN 61010-1:2001, electrical safety requirements for electrical equipment for measurement, control and laboratory. Installation of this instrument should be done by qualified personnel. In order to ensure safe operation, the following instructions should be followed.



This instrument has no power-on switch. An external switch or circuit-breaker shall be included in the building installation as a disconnecting device. It shall be marked to indicate this function, and it shall be in close proximity to the equipment within easy reach of the operator. The switch or circuit-breaker shall meet the relevant requirements of IEC 947-1 and IEC 947-3 (International Electrotechnical Commission). The switch shall not be incorporated in the main supply cord.



Furthermore, to provide protection against **excessive energy** being drawn from the main supply in case of a fault in the equipment, an **overcurrent** protection device shall be installed.

Note

- Do not exceed voltage rating on the label located on the top of the instrument housing.
- Always disconnect power before changing signal and power connections.
- Do not use this instrument on a work bench without its case for safety reasons.
- Do not operate this instrument in flammable or explosive atmospheres.
- Do not expose this instrument to rain or moisture.
- Unit mounting should allow for adequate ventilation to ensure instrument does not exceed operating temperature rating.
- Use electrical wires with adequate size to handle mechanical strain and power requirements. Install without exposing bare wire outside the connector to minimize electrical shock hazards.

EMC Considerations

- Whenever EMC is an issue, always use shielded cables.
- Never run signal and power wires in the same conduit.
- Use signal wire connections with twisted-pair cables.
- Install Ferrite Bead(s) on signal wires close to the instrument if EMC problems persist.

Failure to follow all instructions and warnings may result in injury!

1.2 Description

The iServer is an Ethernet Server designed to connect devices with serial interfaces to the Ethernet network using the TCP/IP protocol. It contains Ethernet and RS232 or RS485 interfaces.

The standard features include:

- Use standard Web Browser, TCP connection, HTTPget DOS program or Telnet Simulation, for network connectivity.
- Install via RS232/RS485 serial port connection.
- Transfer data from RS232/RS485 serial interface to TCP/IP using built-in socket server.
- Use a standard home page for OEM applications.

The following example illustrates how you can hookup the devices with serial interface on the network using the iServer:

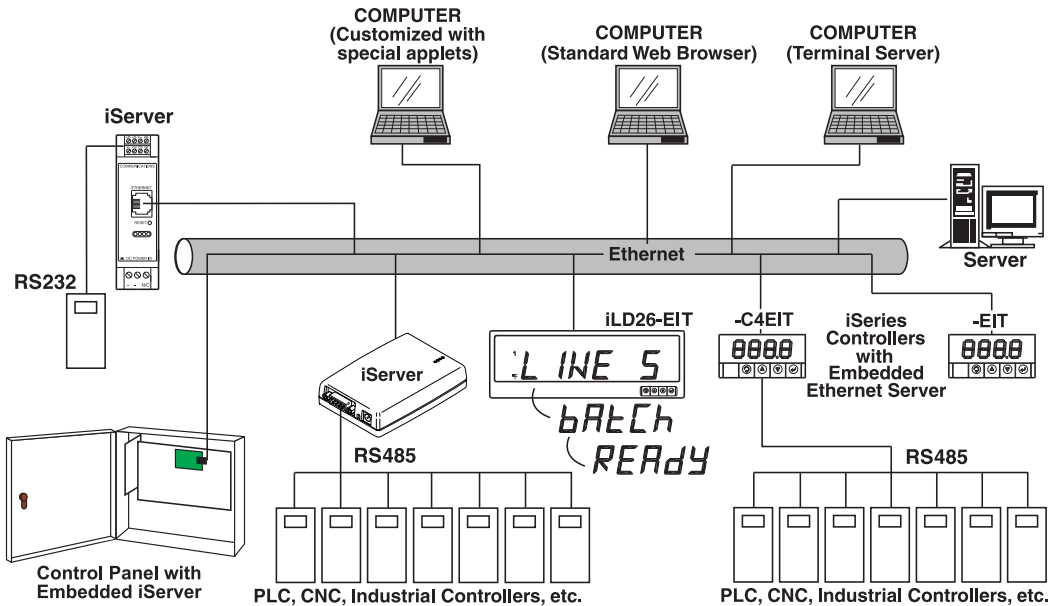

Figure 1.1 Accessing Devices Over the Ethernet

PART 2 HARDWARE

2.1 Physical Characteristics and Mounting

For physical dimensions and installation instructions see Quickstart and Manual for iSeries monitor/controller.

2.2 Rear Panel of iSeries Meter with Embedded Ethernet Server

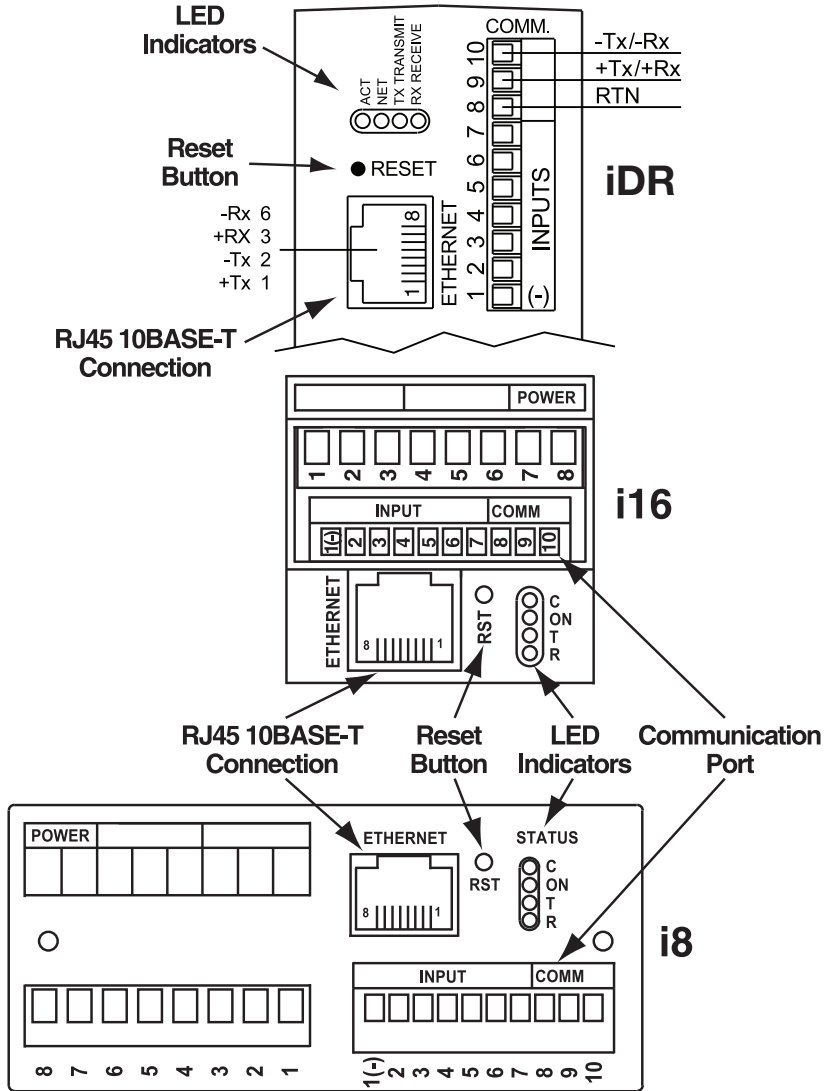

Figure 2.1 Rear Panel View of i16, i8 and iDR Series Meters with Embedded Ethernet Server

Table 2.1 Rear Panel Annunciators

Serial Communication Interface Section (For -C4EIT):	
Pin 10	-Rx/Tx
Pin 9	+Rx/Tx
Pin 8	Return, Common Ground Shield connection
Network Communication Interface Section:	
ETHERNET	RJ-45 interface for 10BASE-T connection.
RESET	Button: Used for power resetting the iServer.
C / ACT	LED (Green) not active.
ON / NET	LED (Green) Solid: Indicates good network link.
T / TX	LED (Yellow) Blinking: Indicates transmitting data to the serial port.
R / RX	LED (Green) Blinking: Indicates receiving data on the serial port.

2.3 Serial Communication Interfaces (For Models with -C4EIT)

The iSeries controller/monitor with Embedded Ethernet Server option supports only RS485/422 interfaces to slave instruments with RS485 interfaces (ex: i833-C24). This allows the use of one TCP/IP address assigned to the master unit (-C4EIT) to communicate with multiple slave units (-C24). See **Figure 2.3**.



-C4EIT master unit acts as hub (Web Server), but it cannot initiate an outside connection with RS485. The serial portion of this option is used to slave multiple RS485 units together using the one IP address of that master unit (-C4EIT).

The **RS485** standard (**multi-point**) allows one or more devices (multi-dropped) to be connected to the Ethernet Server using a two-wire connection (half-duplex) +Rx/+Tx and -Rx/-Tx. Use of RS485 communications allows up to 32 devices to connect to the Web Server with cable length up to 4000 feet long.

Although the RS485 is commonly referred to as a "two wire" connection, the Web Server also provides a ground/return shield connection to use as a common connection for EMI noise protection.

Table 2.2 shows some characteristics of the RS485 communication interface.

Table 2.2 Data Transmission Characteristics RS485

Data Transmission Characteristics	RS485
Transmission Mode	Differential
Electrical connections	2 wire
Drivers per line	32 drivers
Receivers per line	32 receiver
Maximum cable length	4000 ft (1200 meters)

2.3.1 Wiring Master/Slave Units via RS485 Interface

RS485 interface uses a two-wire communication system (one for transmitting and one for receiving) plus a common wire to connect to the shield of the cable. It is recommended to use a shielded cable with one twisted pair.

Note ES[®] Use of twisted pair and shield will significantly improve noise immunity.

Figure 2.3 shows multi-point, half-duplex RS485 interface connections for the iServer.

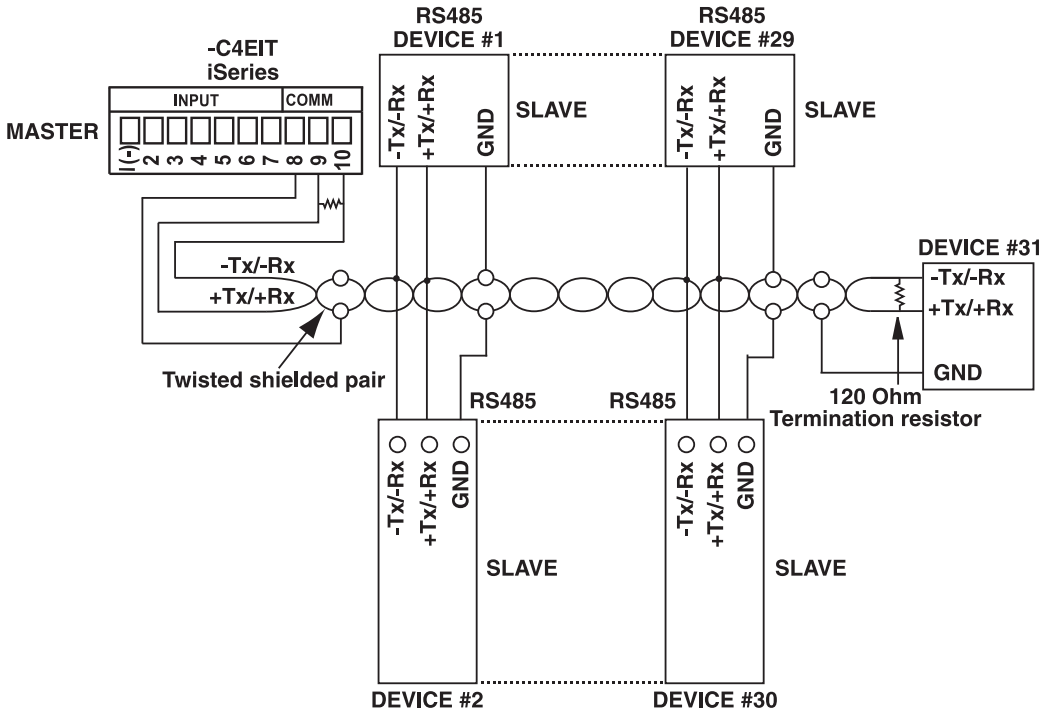

Figure 2.2 Multi-point, Half-Duplex RS485 Wiring

Note ES[®] Value of the termination resistor is not critical and depends on the cable impedance.

Table 2.3 shows RS485 half-duplex hookup between the iServer serial port and device with RS485 communication interface.

Table 2.3 Half Duplex Hookup

Pin#	iSeries	DEVICE # WITH RS485
Pin 9	+Tx/+Rx (+Transmit/+Receive)	+Tx/+Rx (+Transmit/+Receive)
Pin 10	-Tx/-Rx (-Transmit/-Receive)	-Tx/-Rx (-Transmit/-Receive)
Pin 8	RTN (Common GND)	GND (Common GND)

2.4 Network Communication Interfaces

2.4.1 10BASE-T RJ-45 Pinout

The 10BASE-T Ethernet network system is used in the iServer for network connectivity. The 10 Mbps twisted-pair Ethernet system operates over two pairs of wires. One pair is used for receiving data signals and the other pair is used for transmitting data signals. This means that four pins of the eight-pin connector are used.

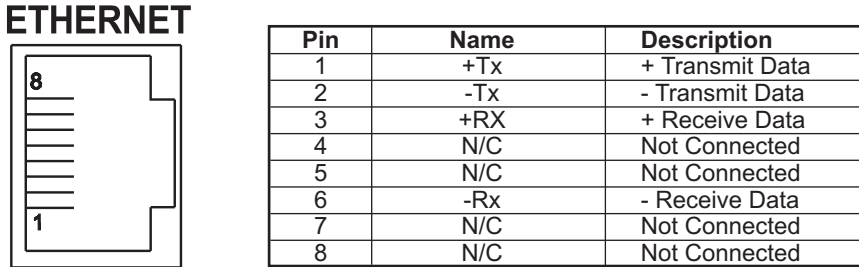

Figure 2.3 RJ-45 Pinout

2.4.2 Connecting iServer to PC/Hub/Switch/Router

The iServer's Ethernet interface can automatically detect the Rx and Tx lines on a twisted pair Ethernet cable (MDI/MDIX Auto Cross). Therefore, to connect an iServer to a PC/Hub/Switch/Router, either a straight-through or a cross-over cable can be used.



On certain devices (like iServer), it is possible for the hardware to automatically correct errors in cable selection, making the distinction between a “straight-through” cable and a “cross-over” cable unimportant. This capability is known as “Auto MDI/MDIX”.

You may need to power recycle for auto detect to take place.

PART 3 NETWORK CONFIGURATION

3.1 Network Protocols

The iServer can be connected to an Ethernet network using standard IP protocols including TCP, UDP, SNMP, SMTP, ARP, HTTP (WEB server), DHCP, DNS, Telnet, and Modbus TCP/IP.

3.2 Ethernet (MAC) Address

MAC (Media Access Control) address is your computer's unique hardware number. When you're connected to the LAN from your computer, a correspondence table relates your IP address to your computer's physical (MAC) address. The MAC address can be found on the label of your device and contains 6 bytes (12 characters) of hexadecimal numbers XX:XX:XX:XX:XX:XX hex

For example: 0A:0C:3D:0B:0A:0B

Note Remove the small label with the default IP address and there will be room to put your IP address. See **Figure 3.1** thru **Figure 3.3**.

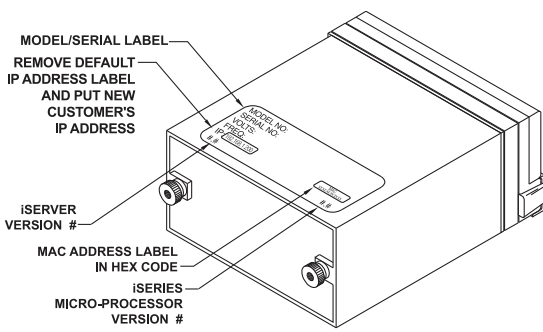

Figure 3.1 i8 - Labeling

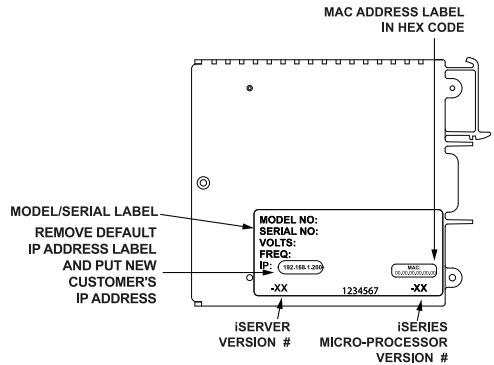

Figure 3.2 iDR - Labeling

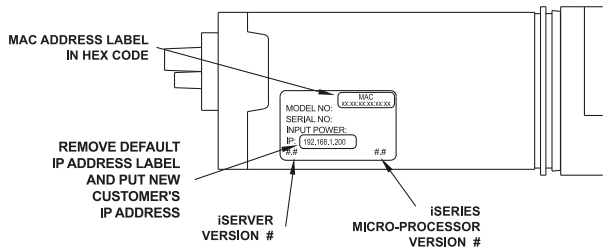

Figure 3.3 i16 - Labeling

3.3 DHCP

DHCP, Dynamic Host Configuration Protocol, enables computers and devices to extract their IP configurations from a server (DHCP server).

If DHCP is enabled on your iServer, as soon as the iServer is connected to the network, there is an exchange of information between the iServer and the DHCP server. During this process the IP address, the Gateway address, and the Subnet Mask, will be assigned to the iServer by the DHCP server. Note that the DHCP server must be configured correctly to do such assignment.

The iServer is shipped with DHCP disabled (factory default).

If fixed or static IP address is desired, the DHCP function must be disabled.

The DHCP can be enabled by accessing the iServer's web server and selecting Network option (refer to **Section 4.5.2**).



1. It is very important to communicate with the network administrator in order to understand DHCP and its existing configurations on the host server, before enabling DHCP on the iServer.
2. The iServers are shipped with a default static IP address of **192.168.1.200** and Subnet Mask of **255.255.255.0**.
3. On Windows servers where DHCP and DNS are separate functions it's very important to configure DHCP server to communicate with DNS in order for the iServer's Host Name to correctly respond. If you cannot access the iServer using its Host Name, please contact your network administrator to make sure DHCP and DNS servers are linked together.

3.4 DNS

DNS, Domain Name System enables computers and devices to be recognized over a network based on a specific name instead of IP addresses.

For example, instead of having to use **http://192.168.1.200** (IP address), you would use only **http://eit0a0b** or any eight character name stored as Host Name under Access Control menu in the iServer Home Page.

The default DNS name for an iServer is **"eit"** followed by the last four digits of the MAC address of that particular iServer.

3.5 IP Address

Every active device connected to the TCP/IP network must have a unique IP address. This IP address is used to build a connection to the iServer itself and the serial device connected to the iServer's serial port. All network devices like computers that use TCP/IP protocol to communicate with each other should have a unique 32-bit address called IP address.

The IP address is divided into two portions, the network ID and the host ID. For instance, every computer on the same network uses the same network ID. At the same time, all of them have different host IDs.

For more details about the IP address see **Appendix B**.

3.6 TCP Port (Socket) Number

All TCP connections are defined by an IP address and a port number. A port number is an internal address that provides a TCP/IP interface between an application software on a computer and a device on the network.

There are three default TCP port (socket) numbers assigned to the iServer:

1. **Port 1000:** Once a TCP connection is made to the iServer using port 1000, the iServer will forward the connection to the serial device and it will take the response from the serial device and send it out to the network.
2. **Port 2000:** Once a TCP connection is made to the iServer using port 2000 (or any port number that is configured on the iServer), the iServer will forward the connection to the serial device and it will take the response from the serial device and send it out to the network.
3. **Port 2002:** This port is the iServer's network console port for reading or changing the iServer's settings. This can be done using a Telnet application.

Example: **C:\>Telnet 192.168.1.200 2002**

PART 4 OPERATIONS

This iServer can be configured in several ways, depending on user's preference and network setup. It can be configured using a Web browser like Chrome, Internet Explorer, or Firefox to access its Web server. It can also be configured using a TCP connection to port 2002 using a command line interface. The iConnect Configuration Software can also be used to find and configure the iServer over the Ethernet.

4.1 SERIAL INTERFACE CONFIGURATION - Communication Protocol

A data communication protocol defines the rules and structure of messages used by all devices on a network for data exchange. A typical transaction will consist of a request to send from the MASTER followed by the response from one or more SLAVE devices. Either a single (point-to-point) or multi-drop network (multi-point) is possible.

4.2 Command Structure

There are different command types associated with communication between the Ethernet Server and your device shown in **Table 4.1**, which shows the Command Prefix Letters (Command Classes)

Table 4.1 Command Prefix Letters

COMMAND PREFIX (COMMAND CLASS)	MEANING
^AE	Special read, Communication parameters
P (Put)	Write HEX data into RAM
W (Write)	Write HEX data into EEPROM.
G (Get)	Read HEX data from RAM
R (Read)	Read HEX data from EEPROM
U	Read status byte
V	Read measurement data string in decimal format
X	Read measurement data values in decimal format
D	Disable
E	Enable
Z	Reset

4.3 Command Formats

Table 4.2 shows the command formats for the Ethernet Server.

Table 4.2 Command Formats

For "P" and "W" Command classes:	For "G" and "R" Command classes:	For "X", "V", "U", "D", "E", & "Z" Command classes:
Point-to-point mode * ccc<data><cr>	Point-to-point mode * ccc <cr>	Point-to-point mode * ccc <cr>
Multi-point mode * ncccc [<data>]<cr>	Multi-point mode * ncccc <cr>	Multi-point mode * ncccc <cr>

Where:

"*" is the selected Recognition Character. You may select any ASCII table symbol from "!" (HEX address "21") to the right-hand brace (HEX "7D") except for the caret "^", "A", "E", which are reserved for bus format request.

"ccc" stands for the hex-ASCII Command Class letter (one of eleven given in **Table 4.1**), followed by the two hex-ASCII Command Suffix characters identifying the meter data, features, or menu items to which the command is directed.

"<data>" is the string of characters containing the variable information the computer is sending to the meter. These data (whether BCD or binary) are encoded into hex-ASCII character (see Appendix D for binary-hex-ASCII chart), two characters to the byte. Square brackets [indicating optional status] enclose this string, since some commands contain no data.

"<nn>" are the two ASCII characters for the device Bus Address of RS485 communication. Use values from "00" to hex "C7" (199 decimal).

The following format is used for each byte sent and received through serial port of Ethernet Server:

1. Seven or Eight-bit binary, Hexadecimal (0 ... 9, A ... F)
2. Two hexadecimal characters contained in each eight-bit field of the message
3. 1 start bit; 7 or 8 data bit; 1 Stop Bit; Odd, Even (No Parity) Bit

The figure below shows the bit sequences when a byte is transmitted or received through the Ethernet Server.

LSB							MSB			
START	1	2	3	4	5	6	7	8	STOP	PARITY

LSB – Least Significant bit

MSB – Most Significant bit

Least Significant bit sent first



Refer to your device's Serial Communication Manual for a list of Commands.

4.4 Default IP Address

The iServer is shipped with a default IP address of **192.168.1.200** and Subnet Mask of **255.255.255.0**. If you are going to use a Web browser or Telnet program to access the iServer using its default IP address, make sure that the PC from which you're establishing the connection has an IP address that is in the same range as the iServer's IP address (**192.168.1.x**, where **x** can be any number from **1** to **254**).

Note Your PC's IP address cannot be the same as the iServer's IP address.

You also need to make sure that your PC's Subnet Mask is 255.255.255.0. This is a good way to access the iServer over the network and make any configuration changes needed.

If 192.168.1.200 is already in use on your network, connect the iServer directly to your computer using a CAT5 Ethernet cable (either straight or cross-over cable will be detected by the iServer) and proceed as described above.

To verify a good connection to the iServer, from a DOS prompt on your computer type "**ping 192.168.1.200**" and press Enter. You should get a reply as shown in **Figure 4.1**.

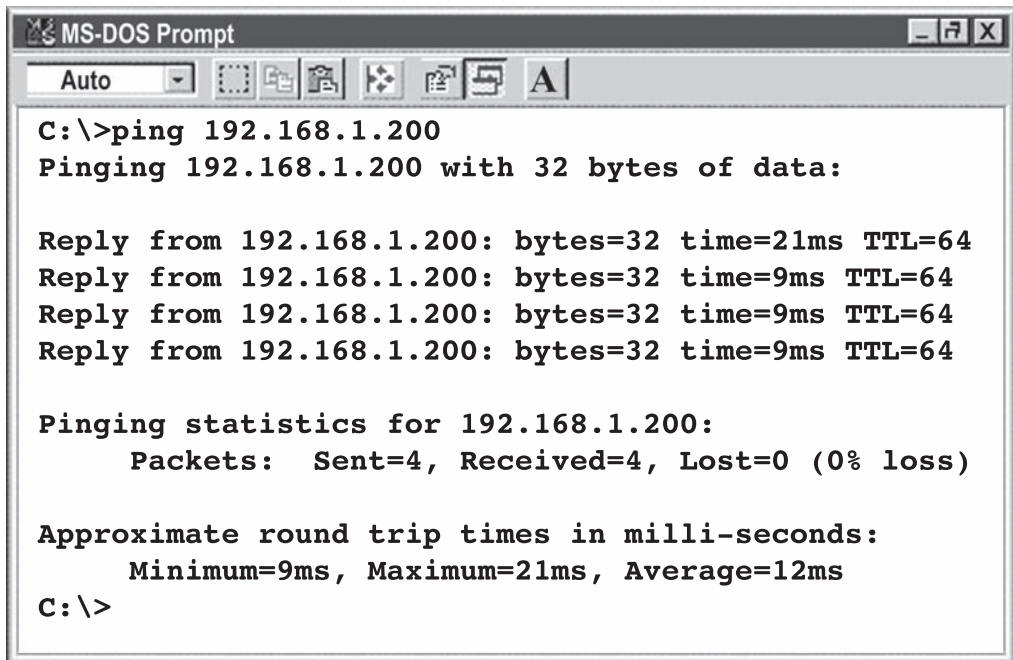

```
MS-DOS Prompt
Auto
C:\>ping 192.168.1.200
Pinging 192.168.1.200 with 32 bytes of data:

Reply from 192.168.1.200: bytes=32 time=21ms TTL=64
Reply from 192.168.1.200: bytes=32 time=9ms TTL=64
Reply from 192.168.1.200: bytes=32 time=9ms TTL=64
Reply from 192.168.1.200: bytes=32 time=9ms TTL=64

Pinging statistics for 192.168.1.200:
    Packets: Sent=4, Received=4, Lost=0 (0% loss)

Approximate round trip times in milli-seconds:
    Minimum=9ms, Maximum=21ms, Average=12ms
C:\>
```

Figure 4.1 Pinging the iServer from a DOS Prompt

4.5 Access and Configuration Using a Web Browser

- Start your web browser.
- In the URL field, type **http://192.168.1.200** (iServer's default IP address)
- The iServer will display the LOGIN page, as shown below.



Figure 4.2 iServer LOGIN Page

Note In order to access iServer's web pages, users may be prompted for a password.

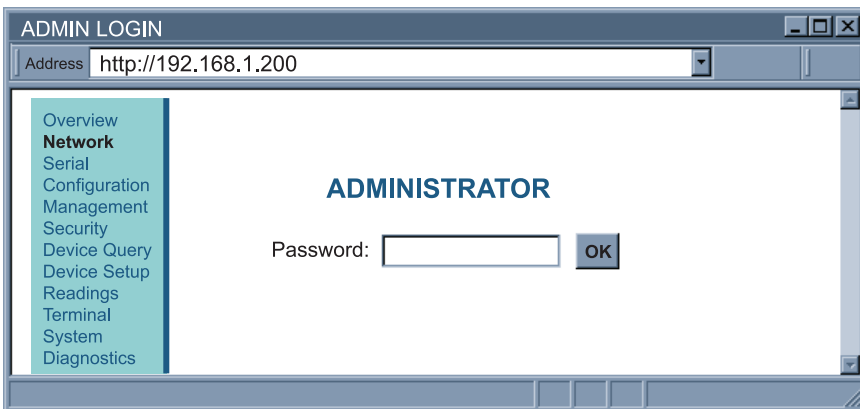

Figure 4.3 iServer LOGIN and ADMINISTRATOR Passwords

There are two different access levels:

1. LOGIN Password is required to access the iServer's web server unless it's disabled. The default password is **12345678**. This password can be up to 16 alphanumeric case-sensitive characters.
2. ADMINISTRATOR Password is required to access NETWORK, SECURITY, and SYSTEM web pages, unless it's disabled. The default password is **0000000**. This password can be up to 16 alphanumeric case-sensitive characters.

4.5.1 Overview

Once the LOGIN password is entered, the OVERVIEW page will appear which provides a summary of important parameters within the iServer.

All the fields are read-only.

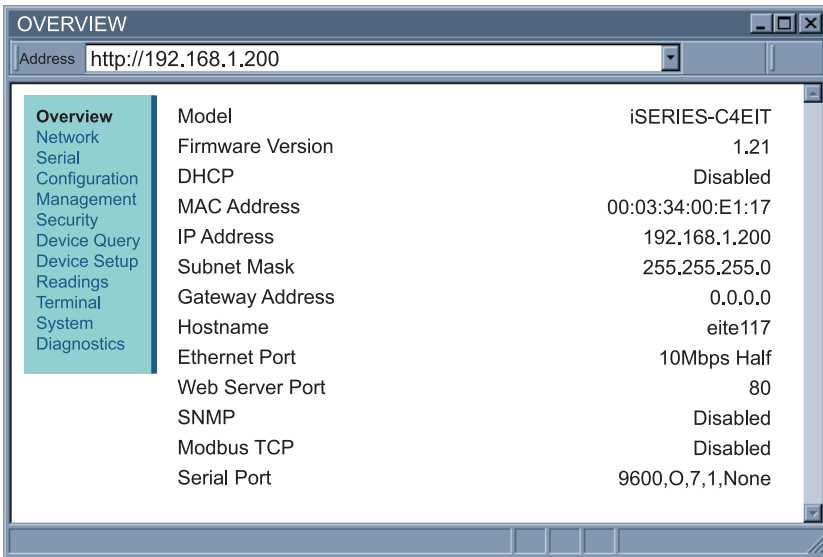

Figure 4.4a iServer -C4EIT OVERVIEW Page

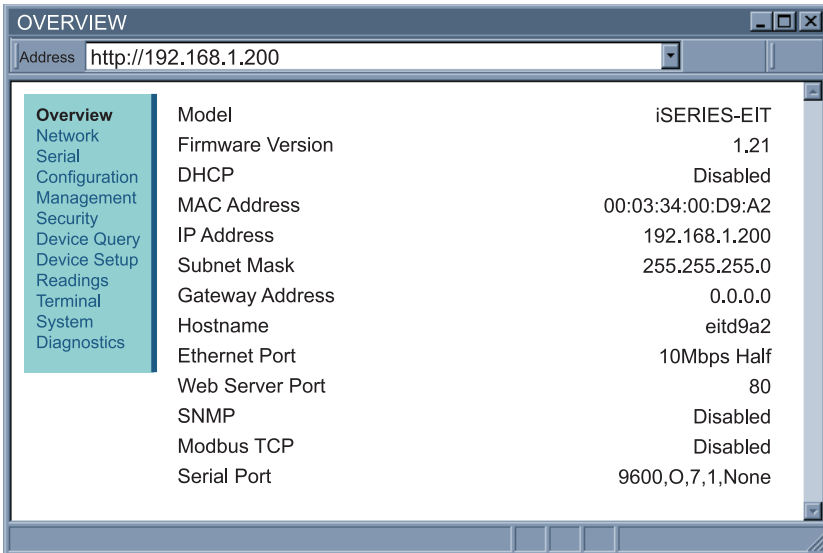

Figure 4.4b iServer -EIT OVERVIEW Page

4.5.2 Network

This page provides configurations for the Ethernet interface and TCP/IP parameters. Fields are described below.

The screenshot shows a web browser window titled "NETWORK" with the address bar containing "http://192.168.1.200". The main content area is titled "IP CONFIGURATION" and features a left-hand navigation menu with the following items: Overview, Network (highlighted), Serial, Configuration, Management, Security, Device Query, Device Setup, Readings, Terminal, System, and Diagnostics. The configuration fields are as follows:

DHCP	<input type="checkbox"/>
MAC Address	00:03:34:00:0A:0B
IP Address	192.168.1.200
Subnet Mask	255.255.255.0
Gateway Address	0.0.0.0
DNS Address	0.0.0.0
Host Name	eit0A0B
Protocol	TCP
Web Server Port	80

At the bottom of the page, there are two buttons: "Save Changes" and "Reset".

Figure 4.5 iServer NETWORK Page

DHCP – If the box is checked the iServer will dynamically request an IP address, a subnet mask, a gateway address, and a DNS address from the DHCP server. By default the DHCP option is disabled.

For more information about DHCP, see **Section 3.3**.

MAC Address – This Indicates the hardware address of the iServer and it's non-configurable.

For more information about MAC Address, see **Section 3.2**.

IP Address – This indicates the IP address of the iServer. The iServer's default IP address is **192.168.1.200**. When DHCP is enabled this field will be dimmed.

Consult with your IT department for obtaining an IP address.

4.5.2 Network (continued)

Subnet Mask – A 32-bit number that is used to determine which part of the IP address is the network portion and which part is the host portion. When DHCP is enabled this field will be dimmed. The iServer's default Subnet Mask is *255.255.255.0*. Consult with your IT department for obtaining a subnet mask.

Gateway Address – This points to the router that forwards traffic to a destination address outside of the subnet on which the iServer resides. This is the IP address of the router which functions as a gateway. When DHCP is enabled this field will be dimmed. The iServer's default Gateway address is *0.0.0.0*. Consult with your IT department for obtaining a gateway address.

DNS Address – In order to use the iServer's DNS feature, the DNS server on your network must be configured. That allows the iServer to use a host's domain name to access the Ethernet node. The iServer plays the role of a DNS client, in the sense that the iServer will actively query the DNS server for the IP address associated with a particular domain name. When DHCP is enabled this field will be dimmed. The iServer's default DNS address is *0.0.0.0*. Consult with your IT department for obtaining a gateway address.

Host Name – If the DHCP is enabled the iServer will send this name to the DHCP server. This name is used so the iServer can be accessed based on a specific name instead of an IP address. For example, instead of using ***http://192.168.1.200*** (IP address), you would use ***http://eit0a0b*** or any name up to eleven alphanumeric characters. The default Host Name for an iServer is "eit" followed by the **last four digits** of the MAC address of that particular iServer.

Note 

On Windows servers where the DHCP and DNS are separate functions it's very important to configure the DHCP server to communicate with the DNS in order for the iServer's Host Name to correctly respond. If you cannot access the iServer using its Host Name, please contact your network administrator to make sure the DHCP and DNS servers are linked together.

Protocol – It's the network protocol the iServer communicates with the Ethernet Network. Options are *TCP*, *UDP*, and *ModbusTCP*. The default is *TCP*.

Web Server Port – The default port is *80*. This is the primary port number for the HTTP protocol used for communication between internet browsers and web sites/web servers. Web servers open this port then listen for incoming connections from web browsers. Similarly, when a web browser is given an IP address (like the iServer's IP address), it assumes that the iServer's web server is listening for connections on port *80*.

If this port is changed to anything but *80* then on the browser the new port number must be indicated with a colon (:) after the IP address. For example, if the Web Server Port is changed to *500*, you will then need to type ***http://192.168.1.200:500*** on the browser to access the iServer's web server.

Note 

One of the applications where the Web Server Port number may need to change is when users want to access the iServer's web server from outside the local area network (i.e. Internet). By setting up "Port Forwarding" inside a router that is the gateway to that local area network this task can be accomplished. "Port Forwarding" technique uses the Web Server Port number to forward the Internet connection to the iServer on the LAN.

4.5.3 Serial (RS485 Serial Port)

These pages provide configurations for the iServer's serial port as well as different techniques for bridging data between serial and Ethernet ports (see **Figures 4.6 through 4.10**). Fields are described below.

Note The RS485 Service Port Tab as shown in **Figure 4.6** will appear only for option C4EIT.

For the iSeries EIT option the following parameters: 9600,O,7,1,none are fixed and the device must be set to these parameters.

For EIT option there will be no tab.

4.5.3.1 RS485 Serial Port

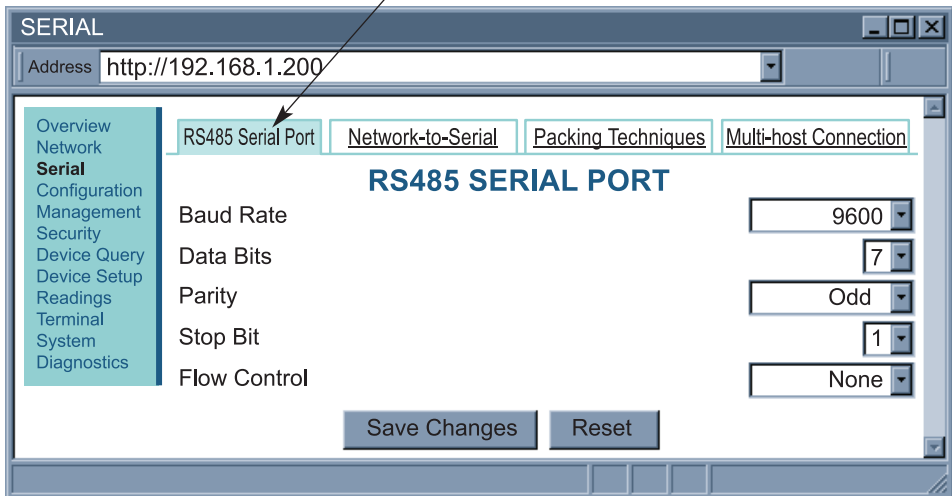

Figure 4.6 iServer SERIAL Page – RS485 Serial Port

Baud Rate – This indicates the speed of the iServer's serial port. Options are 300, 600, 1200, 2400, 4800, 9600, 19200, 38400, 57600, 115200, 230400, and 460800 bits/s. The default is 9600 bits/s.

Note iSeries device maximum Baud Rate is 19.2 kb/s

Data Bits – This indicates the number of bits in a transmitted serial packet. Options are 7 and 8. The default is 7.

Parity – This checks the serial packet for the parity bit. Options are *Even*, *Odd*, and *None*. The default is *Odd*.

Stop Bit – This indicates the end of transmission. Options are 1 and 2. The default is 1.

Flow Control – This handles the data flow between the iServer and the attached serial device to ensure it's processed efficiently. Too much data arriving before the device can handle it causes lost data. Options are *Software* also called Xon/Xoff (using Tx and Rx pins), and *None*. The default is *None*.

4.5.3.2 Network-to-Serial

Note For units with -EIT option the RS485 Serial Port tab will not be part of web page.

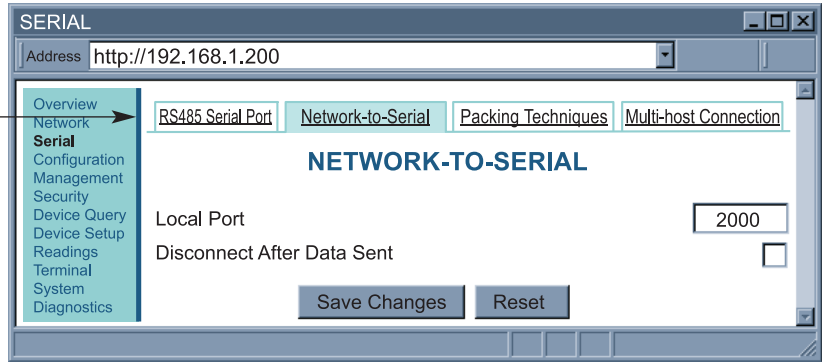

Figure 4.7 iServer SERIAL Page – Network to Serial

Local Port – This is the port number assigned to the iServer’s serial port for the purpose of TCP, UDP, or ModbusTCP connection. Any number between 500 and 9999 can be used with the exceptions of 1000 and 2002 which are reserved by the iServer for other purposes (port 1000 is described in the previous section and port 2002 is the iServer’s Telnet console port). The default is 2000.

Note Port number 502 is the default port number for Modbus/TCP protocol. If Modbus/TCP is enabled in the iServer, set port 502 as the iServer’s Local Port .

Disconnect after Data Sent – If checked, the iServer receives a command, sends it to the serial port and waits for a reply. If a reply is received it will close the connection.

4.5.3.3 Packing Techniques

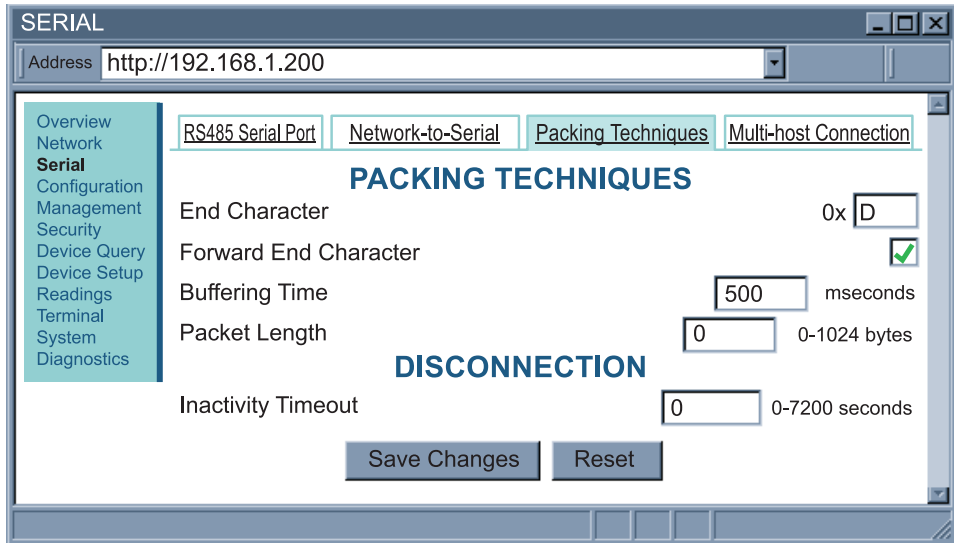

Figure 4.8 iServer SERIAL Page – Packing Techniques

End Character – When this hexadecimal character is received by the iServer on its serial port, the iServer will forward the buffered serial data to the Ethernet.

The default value is *D*, which means the iServer requires no End Character to forward the data to the network.

Forward End Character – If this option is *checked*, the iServer will send the End Character out to the Ethernet as part of the data.

If *unchecked*, the iServer will not count the End Character as part of the data and will drop it. The default is *unchecked*.

Buffering Time – This forces the iServer to buffer the received serial data for the given time value. This option defines the time interval during which the iServer stores the serial data in its buffer before sending it out to the network.

Depending on users' applications, this time must be at least larger than one character interval within the specified baud rate.

For example, assume that the serial port is set to 1200 bps, 8 data bits, 1 stop bit, and no parity.

In this case, the total number of bits needed to send a character is 10 bits and the time required to transfer one character is:

$$(10 \text{ (bits)} / 1200 \text{ (bits/sec)}) * 1000 \text{ (msec/sec)} = 8.3 \text{ msec.}$$

Therefore, the Buffering Time must be larger than 8.3 msec.

If the interval is set to be too long (counting the baud rate in the equation) and therefore the iServer's buffer approaches to get full, the iServer will override the specified time and will push the data out to the network before the buffer is full.

The default is *500* milliseconds.

4.5.3.3 Packing Techniques (continued)

Packet Length – If the received data length (in bytes) matches the entered value, the data will be sent out to the network.

The data length of up to 1024 bytes can be entered.

Enter 0 if you don't need to limit the length. The default is 0.

Inactivity Timeout – This option impacts Network-to-Serial and Serial-to-Network connections.

The iServer will drop the TCP connection if there is no activity before the defined time expires. If 0 is selected there won't be any timeout. The default is 0 seconds.

4.5.3.4 Multi-Host Connection

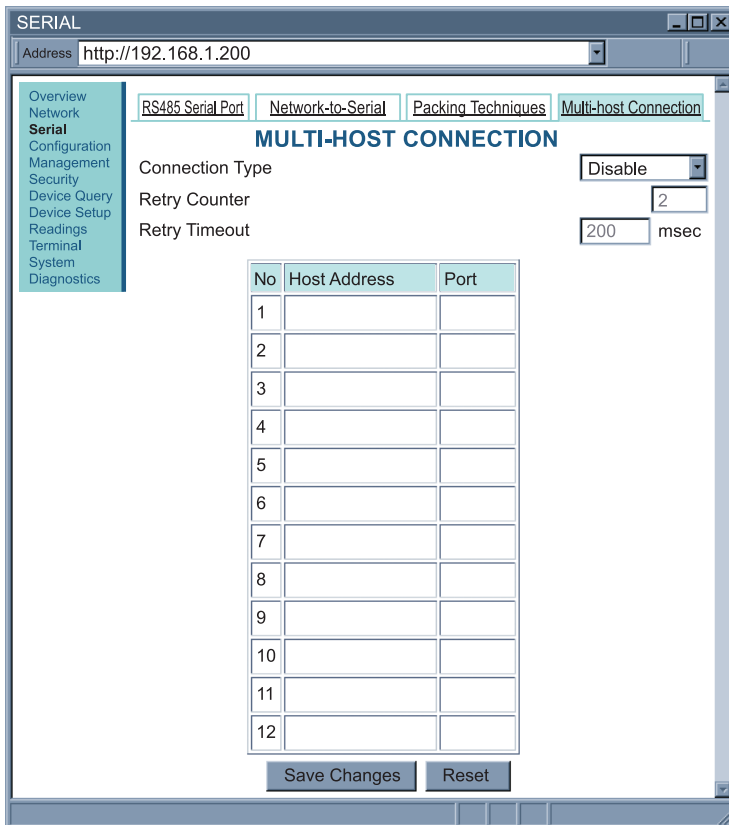

Figure 4.9 iServer SERIAL Page – Multi-Host Connection

4.5.3.4 Multi-host Connection (Continued)

Connection Type – The options are *Disable*, *Simultaneous*, and *Sequential*. The iServer can send the received serial data to multiple network hosts Simultaneously or Sequentially.

In *Simultaneous* mode, the received serial data will be transmitted to all the network nodes that are indicated in the host table (using TCP or UDP protocol depending on which protocol is selected under the NETWORK page).

In *Sequential* mode, the iServer scrolls through the IP addresses in the host table until it connects to one. After a successful connection, the iServer stops trying to connect to any others. If this connection fails, the iServer continues to scroll through the table until the next successful connection takes place.

Each entry in the host table should contain an IP address and a port number. The default is *Disable*.

Retry Counter – This indicates the number of tries to connect to the host address. The default is 2.

Retry Timeout – This indicates the amount of time (msec) between each try. The default is 200 msec.

4.5.4 Configuration

This menu provides configurations for the real-time clock, server parameters, sensors, and alarm relays settings. Fields are described below.

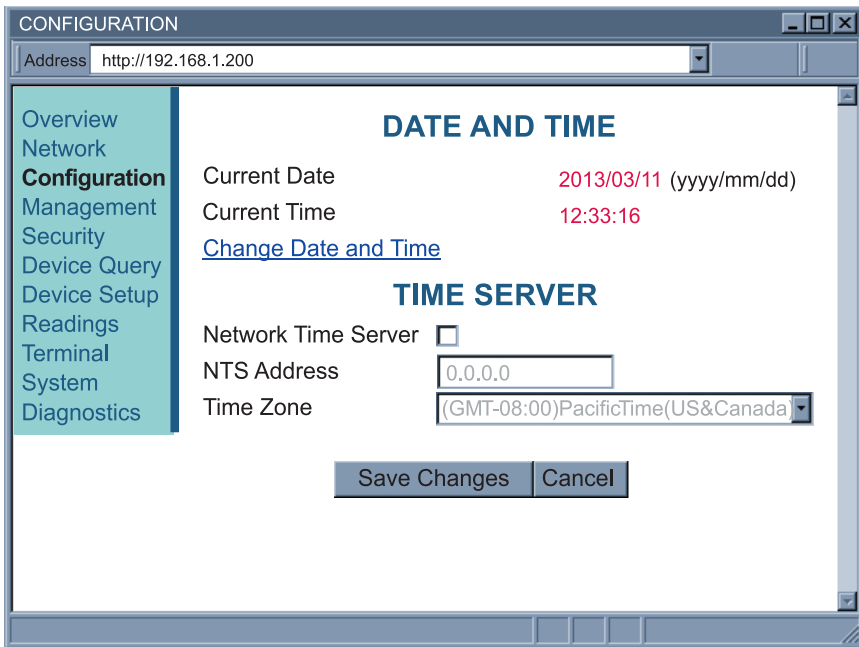

Figure 4.10 iServer CONFIGURATION Page: Ethernet Configuration

4.5.4.1 Date and Time

Current Date – This field indicates the iServer’s real time clock date. The format is *yyyy/mm/dd*. When there is no date defined, the iServer will be defaulted to *2099/01/01* and be shown in red to alert you that it has not yet been set.

Current Time – This field indicates the iServer’s real time clock time. The format is military time (24-hour) and it is entered as *hh:mm:ss*.

Change Date and Time – By clicking on this option the real data and time can be entered.



Once the iServer is rebooted from any web page, the iServer will lose its date and time settings.



If the iServer is setup to get it’s time from a Network Time Server, then the time will be re-assigned after the reboot.

Network Time Server – If there is a time server on the network or the Internet, the iServer will get the real date and time once the Network Time Server’s IP address is provided. Default is *unchecked*.

NTS Address – The field to enter the Network Time Server’s IP address.

The U.S. National Institute of Standards and Technology (NIST) publishes a list of time servers on the Internet used by the NIST Internet Time Service (ITS). The list includes each server’s name, IP address, and location in the United States. As of the publication date of this manual, links to the list can be found at <http://tf.nist.gov>.

Time Zone – If Network Time Server option is checked, the correct time zone must be selected for the correct time display.

4.5.5 Management

This page provides the configuration of the iServer’s email, SNMP and alarm settings. SNMP (Simple Network Management Protocol) is a protocol used by network management systems to communicate with network devices that respond to SNMP connections for the purpose of problem detections and corrections (see **Figures 4.11** and **4.12**). Fields are described below.

The screenshot shows a web browser window titled "MANAGEMENT" with the address "http://192.168.1.200". On the left is a navigation menu with "Management" selected. The main content area has two tabs: "Email,SNMP" and "Alarm". The "SNMP" section includes fields for "SNMP Service" (checked), "SNMP Community" (Public), "Contact" (Joe Smith), "Location" (Station #3), "SNMP Traps" (checked), and "SNMP Trap Server IP" (192.168.1.20). The "EMAIL" section includes fields for "Email Service" (checked), "SMTP Server IP" (192.168.1.10), "SMTP Server Port" (25), "From:" (joe.smith@_____.com), "Subject:" (Alarm from iServer), "To:" (bill.jones@_____.com), and "Reminder Interval" (5 minutes). "Save" and "Reset" buttons are at the bottom.

Figure 4.11 iServer MANAGEMENT Page – Email, SNMP

4.5.5.1 Management - Email SNMP

SNMP Service – This option is used to enable the SNMP service. The default is *unchecked*.

SNMP Community – Every SNMP communication takes place using a community string. It's configurable to either *public* or *private*. *Public* is the default.

Contact – This field specifies the contact name to which the SNMP trap is sent. This field allows the trap to address a particular person. It is similar to the word "Attn:" in the subject line of an email.

Location – This field specifies the location of the iServer. For example, it can be "Boiler Control Station #3" which is the place where the iServer and the serial device are located. Each SNMP trap will have both the contact and location information in it to help identify where the trap is coming from and whom it is meant for.

SNMP Traps – This option allows the customer to enable traps in SNMP. Traps are UDP data packets sent to an IP address (Trap server IP) by iServer and contain contact and location information and also OID (Object ID) for a trap.

SNMP Trap Server IP – This field contains the IP address of the trap server located somewhere on your network. The trap server listens for SNMP traps coming from the iServer. Third-party trap server software can be found on the internet for download.

Email Service – This option enables the email service on the iServer. The iServer uses SMTP (Simple Mail Transfer Protocol) with port number 25 to send emails. The default is *unchecked*.

 You must have an email server (SMTP server) on your network in order to receive emails generated by the iServer.

SMTP Server IP – This field specifies the IP Address of the SMTP server.

 iServer does not support SMTP server authentication.

SMTP Server Port – This is a read only field specifying the standard port number 25 used by the SMTP Server.

From – This field specifies the name of the person that will send email. It can also be an email address. Only one name or email address is allowed at a time with space or comma in between

Subject – This field specifies the subject of the email to send. All emails will have this common subject. Example of a subject can be "Alarm from iServer".

To – This field contains the email addresses of people that will be getting the email for a particular alarm. If multiple emails are to be sent then the names need to be separated by a comma.

Reminder Interval – This field sets a reminder interval for either an email or a trap to be sent again. The allowed minimum value is 5 minutes and the maximum value is 300 minutes.

Only the options Input Pin and Serial Port Disconnected use this Reminder Interval. Power Reset email is sent only once.

IP Address Changed, iServer Accessed and Character 1, 2 options send email/trap whenever the conditions occur.

4.5.5.2 Management - Alarm

Events	Email	SNMP Trap
Power Reset <input type="text" value="power reset"/>	<input type="checkbox"/>	<input type="checkbox"/>
IP Address Changed <input type="text" value="ip address changed"/>	<input type="checkbox"/>	<input type="checkbox"/>
iServer Accessed <input type="text" value="iserver accessed"/>	<input type="checkbox"/>	<input type="checkbox"/>
Character 1 <input type="text" value="0x00"/> Character 2 <input type="text" value="0x00"/> <input type="text" value="serial character found"/>	<input type="checkbox"/>	<input type="checkbox"/>

Figure 4.12 iServer MANAGEMENT Page – Alarm

Power Reset – Email – This option enables iServer to send an email when it is rebooted.

Power Reset – Trap – This option enables iServer to send a trap when it is rebooted.

IP Address Changed – Email – This option enables iServer to send an email when the iServer's IP Address is changed.

IP Address Changed – Trap – This option enables iServer to send a trap when the iServer's IP Address is changed.

iServer Accessed – Email – This option enables iServer to send an email when the iServer is accessed on Port 2000.

iServer Accessed – Trap – This option enables iServer to send a trap when the iServer is accessed on Port 2000.

Character 1,2 – Email – This option enables the iServer to send an email when the iServer receives on its serial port, the character specified in the field Character 1 or Character 2.

Character 1,2 – Trap – This option enables the iServer to send a trap when the iServer receives on its serial port, the character specified in the field Character 1 or Character 2.

4.5.5.2.1 Sending Txt Messages to a Cell Phone

Note

To send an alarm as a text message to your cell phone you need to enter the email address that is associated with your cell phone number. For example: 7145551212@xxxx.xxx where 714-555-1212 is the cell phone number and xxxx.xxx is the domain name for the telecomm provider. You'll just need to find the correct email format for your cell phone provider. Here are a few examples of email formats for providers in the U.S.

T-Mobile	phone_number@tmomail.net
Virgin Mobile	phone_number@vmobl.com
AT&T	phone_number@txt.att.net
Sprint	phone_number@messaging.sprintpcs.com
Verizon	phone_number@vtext.com
Nextel	phone_number@messaging.nextel.com

4.5.6 Security

This page provides security and access settings for the iServer. Administrator password (default is 00000000) is required to access the SECURITY page. Fields are described below.

The screenshot shows the SECURITY page with the following details:

- Address: http://192.168.1.200
- Navigation menu: Overview, Network, Serial, Configuration, Management, **Security**, Device Query, Device Setup, Readings, Terminal, System, Diagnostics
- SECURITY section:
 - Login Password: 12345678 (change)
 - Administrator Password: 00000000 (change)
 - Local Port Password: (empty) (change)
 - Telnet Console Access:
 - Web Server Access:
- IP EXCLUSIVITY section:
 - Enable:
 - Table with 8 rows, each with a 'No' and an 'IP Address' field, all containing '0.0.0.0'.
- Buttons: Save, Reset

Figure 4.13 iServer SECURITY Page

Login Password – To access the iServer’s web server this password is required. The password length can be up to 16 alphanumeric case-sensitive characters. To change the password click on **change**. Empty box means no password is required. The default Login Password is 12345678.

Administrator Password – To access NETWORK, SECURITY, and SYSTEM pages, this password is required. The password length can be up to 16 alphanumeric case-sensitive characters. To change the password click on **change**. Empty box means no password is required. The default Administrator Password is 00000000.

Note This password will also be prompted when Telnet to port 2002 is made. Port 2002 is the Telnet console port that allows users to configure all the iServer parameters that can be configured through the web server.

Local Port Password – To access the iServer’s serial port (via TCP or UDP socket connection) this password is required (port 2000 is the iServer’s default serial port number). The password length can be up to 16 alphanumeric case-sensitive characters. To change the password click on **change**. Empty box means no password is required. The default Serial Port Password is *none*.

4.5.6 Security (continued)

Telnet Console Access – If checked, Telnet to the iServer’s port 2002 is allowed. The default is *checked*.

Note The password for the Telnet Console Access is the same as the Administrator Password.

Web Server Access – If checked, a web browser can be used to connect to the iServer’s web server. If unchecked, access to the iServer’s web server will be blocked. The default is *checked*.

IP Exclusivity – This table contains all the IP Addresses for the network nodes that are allowed to communicate with the iServer.

If the table is empty then all the network nodes will be allowed to connect to the iServer. If enabled, all packets from IP Addresses that are not on this list will be ignored and thrown away. The default is *Disable*.

4.5.7 Device Query

This page allows you to send a command to a single serial device connected to the iServer and displays the response back from that serial device.

If the connection is RS485, the RS485 node number must be typed before the actual command. Example: ***01** is the RS485 node number 1 and the **X01** is the actual command requesting temperature value.

Refer to your device’s Serial Communication Manual for a list of Commands.

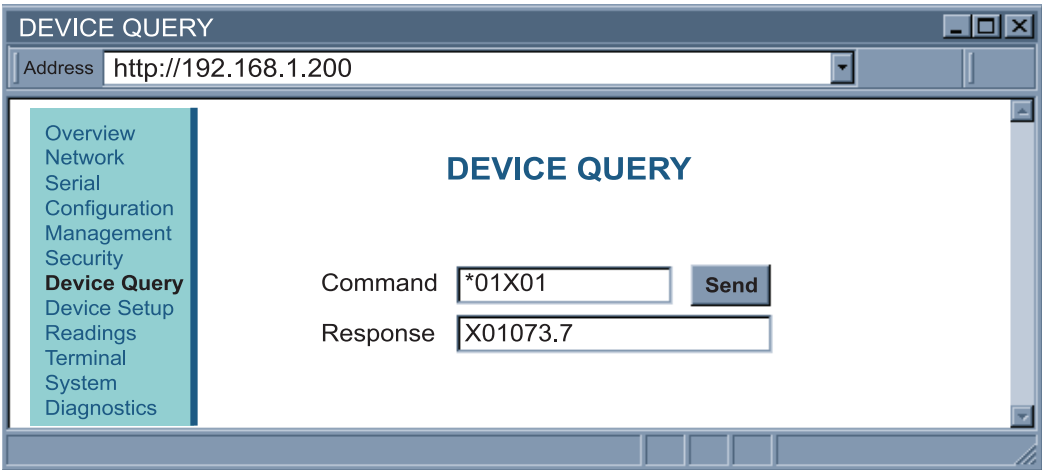

Figure 4.14 iServer DEVICE QUERY Page

4.5.8 Device Setup -C4EIT

This option allows the users to add up to eight device names, commands and a response unit. The iServer will send the entered commands on the serial port and will receive the responses from those devices. Clicking on **Readings** page link will show the response.

On this page there is a Device Number column (No), which has numbers from 1 to 8. These numbers are links to the parameters of each device; click on them to enter the device name, address, command and unit.

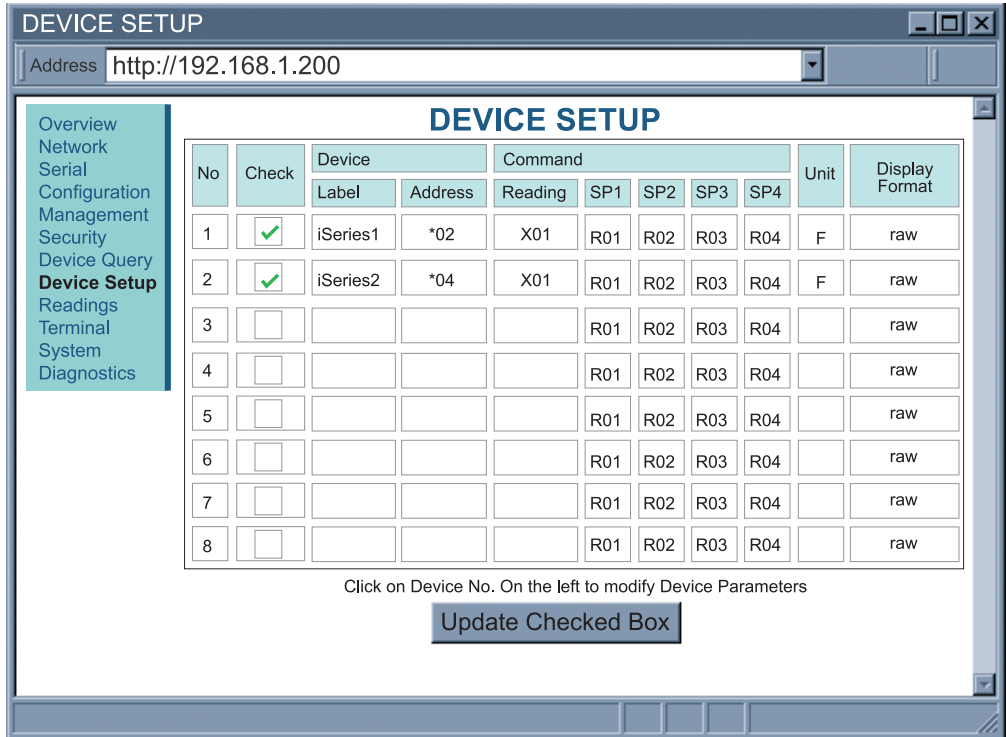

Figure 4.15 iServer DEVICE SETUP Page – RS485 (-C4EIT)

4.5.8.1 Device Parameters -C4EIT

After clicking on any of the numbers (1 through 8), you will be directed to the DEVICE PARAMETERS page.

Device name - This field allows you to enter the device name and can take up to eight alphanumeric characters. Default is blank.

Device address - This column only appears for RS485 (-C4EIT). Device address or ID is in HEX format. See **Appendix D** for conversion. Default is blank.

Reading command - This field is where the actual command is typed.

The iServer will send this command to the serial device as soon as the READINGS page link is clicked. Default is blank.

Setpoint - This field is where the setpoint command is typed.

Response unit - This field is the response unit and can take up to eight alphanumeric characters. Default is blank.

Display format - How the value appears on the READINGS page; choice of *raw* which includes the command or *decimal* which just shows the value.

The screenshot shows a web browser window titled "DEVICE SETUP" with the address bar containing "http://192.168.1.200". The main content area is titled "DEVICE PARAMETERS No. 1". On the left, a navigation menu lists: Overview, Network, Serial, Configuration Management, Security, Device Query, **Device Setup**, Readings, Terminal, System, and Diagnostics. The main form contains the following fields:

Device name	<input type="text" value="iSeries1"/>
Device address	<input type="text" value="*02"/>
Reading command	<input type="text" value="X01"/>
Setpoint 1 command	<input type="text" value="R01"/>
Setpoint 2 command	<input type="text" value="R02"/>
Setpoint 3 command	<input type="text" value="R03"/>
Setpoint 4 command	<input type="text" value="R04"/>
Response Unit	<input type="text" value="F"/>
Display Format	<input type="text" value="raw"/>

At the bottom of the form are two buttons: "Save Changes" and "Reset".

Figure 4.16 iServer DEVICE PARAMETERS Page (-C4EIT)

In RS485 connection, the RS485 node number must be typed before the actual command. Example: ***01** is the RS485 node number 1 and the **X01** is the actual command requesting temperature value.

4.5.8.2 Device Setup -EIT

This option allows the users to add up to eight device labels, commands and a response unit. The iServer will send the entered commands on the serial port and will receive the responses from those devices. Clicking on **Readings** page link will show the response.

Note You can setup and display your device's different values (e.g. Peak and Valley). Refer to your device's Serial Communication Manual for a list of Commands.

On this page there is a Device Number column (No), which has numbers from 1 to 8. These numbers are links to the parameters of the device; click on them to enter the device name, command and unit.

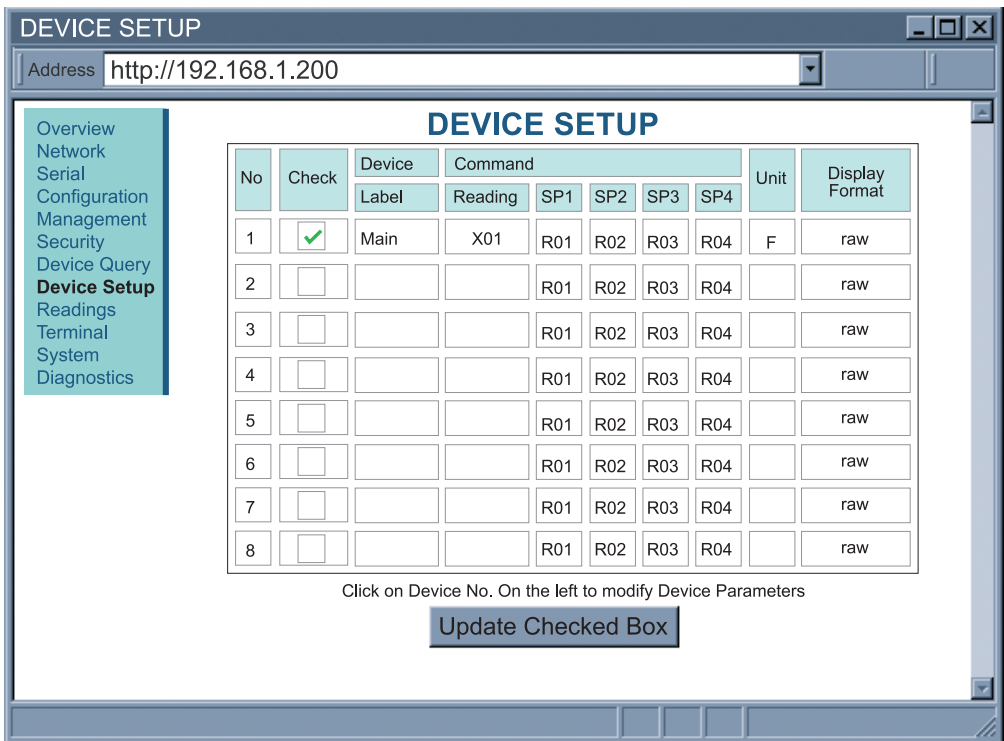

Figure 4.17 iServer DEVICE SETUP Page (-EIT)

4.5.8.3 Device Parameters -EIT

After clicking on any of the numbers (1 through 8), you will be directed to the DEVICE PARAMETERS page.

Device name - This field allows you to enter the device name and can take up to eight alphanumeric characters. Default is blank.

Reading command - This field is where the actual command is typed.

The iServer will send this command to the serial device as soon as the READINGS page link is clicked. Default is blank.

Setpoint - This field is where the setpoint command is typed.

Response unit - This field is the response unit and can take up to eight alphanumeric characters. Default is blank.

Display format - How the value appears on the READINGS page; choice of *raw* which includes the command or *decimal* which just shows the value.

The screenshot shows a web browser window titled "DEVICE SETUP" with the address "http://192.168.1.200". The main content area is titled "DEVICE PARAMETERS No. 1". On the left, a navigation menu lists: Overview, Network, Serial, Configuration, Management, Security, Device Query, **Device Setup**, Readings, Terminal, System, and Diagnostics. The main area contains the following fields:

Device name	Main
Reading command	X01
Setpoint 1 command	R01
Setpoint 2 command	R02
Setpoint 3 command	R03
Setpoint 4 command	R04
Response Unit	F
Display Format	raw

At the bottom of the page are two buttons: "Save Changes" and "Reset".

Figure 4.18 iServer DEVICE PARAMETERS Page (-EIT)

Note In the embedded -EIT option, the command used is **X01** without the "*" character.

4.5.9 Readings

After adding the Device Parameters, including the Command, clicking on the READINGS page allows you to monitor the response back from the serial device. You can access the setpoints by clicking on the numbers 1 to 8.

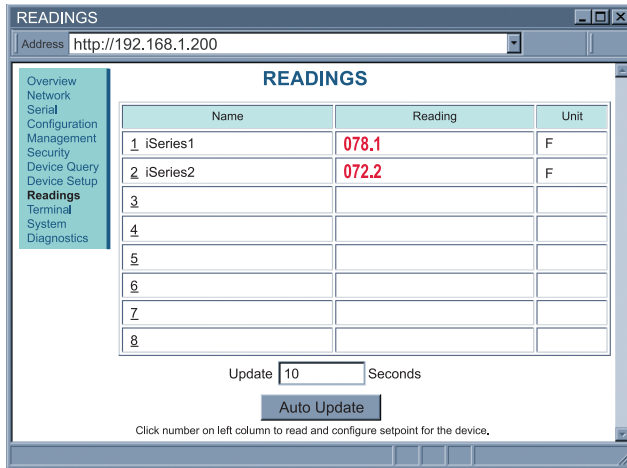

Figure 4.19 iServer READINGS Page (-C4EIT)

Auto Update - To change the time interval of the page refresh, enter the amount of seconds in the box. If you want to manually refresh the page, refresh your browser or click on Readings.

4.5.9.1 Readings - Device Setpoints

Note

Wait 10 seconds for the readings to update prior to accessing the setpoints or the value will not be valid.

Setpt 1, 2 3 4 - This field is where you enter the setpoint values.

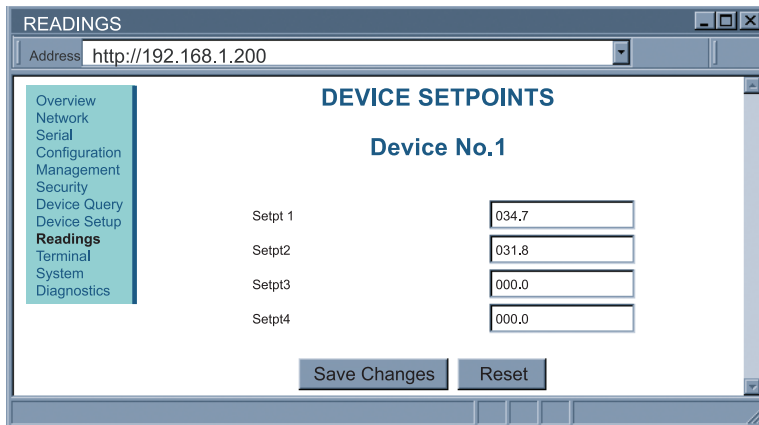

Figure 4.20 iServer DEVICE SETPOINTS Page

4.5.10 Terminal

On this page you can send and receive data to and from the serial device. Simply, type the command in the white area and as you type the characters, the characters will be transmitted out from the serial port of the iServer. If you want to send the whole command as a word, simple paste the word in the same area. This is an excellent tool to retrieve data from the serial port without any special software, only a web browser.

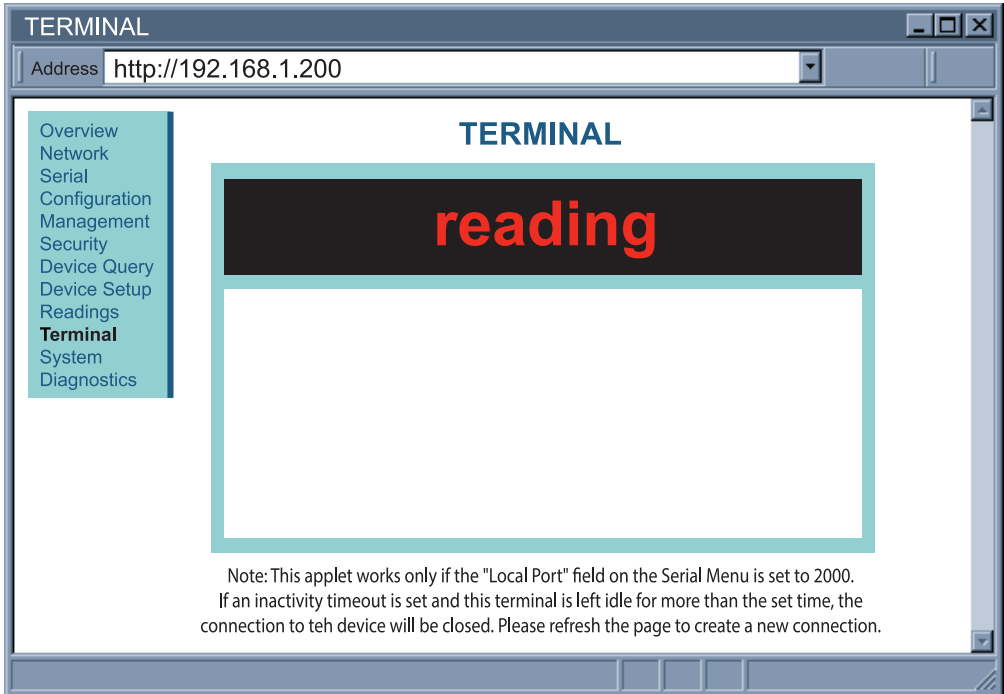

Figure 4.21 iServer TERMINAL Page

4.5.11 System

This page provides various options to reboot, restore defaults, upgrade firmware and download/upload configuration for the iServer. Fields are described below.

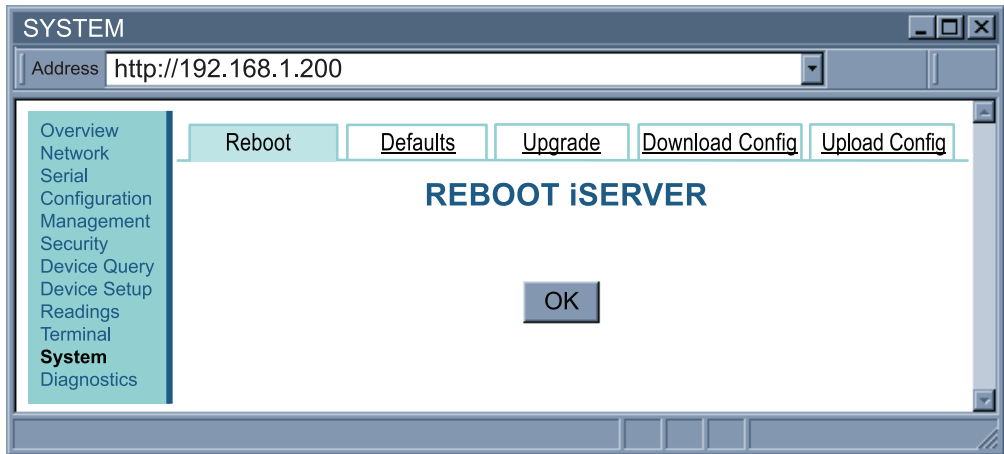

Figure 4.22 iServer SYSTEM Page

Reboot – Clicking on OK button will reboot the iServer.

Note After rebooting, please wait 15 seconds before reconnecting.

Defaults – Clicking on OK button will reset the iServer to factory default settings.

Note After *Defaults*, you need to reboot.

Upgrade – Before proceeding with the firmware upgrade, enter the name of the file you plan to use, click on *Check File Name* button.

If OK, a new screen will appear and you can then browse to the actual upgrade firmware file "**iSeries_EIT_x.bin**" and click on the *Upload* button.

After the file has upgraded the iServer will automatically reboot and load the new firmware, you will be returned to the Welcome page.

Note Before upgrading, it is recommended to save the configuration *Download Config*.

After upgrade load *Defaults*. IP default is **192.168.1.200**.

It is recommended to reboot after loading *Defaults*.

If you do not reboot the unit will not load the configurations.

After connecting to the IP via the web browser, upload the saved configuration file, *Upload Config*.

Download Config – Using this option you can download the configuration file that contains all the settings stored in the iServer and use it as a reference.

Upload Config – Using this option you can upload the saved configuration file to the iServer.

Note It is recommended to download and store a working copy of this configuration file in case the device is configured improperly. You can then set the iServer to its default settings and upload the configuration file again.

Reboot is required anytime the “Defaults” has been loaded, or there has been changes to the network parameters or serial parameters.

Before reboot a message will appear asking if you are sure you want to proceed with the reboot. If you choose to reboot, please wait 15 seconds before reconnecting.

4.5.12 Diagnostics

This page provides diagnostic information for the iServer. It includes information such as Serial port or Ethernet data received or transmitted and has the ability to reset the counters. Also other network devices can be pinged from here. Fields are described below.

The screenshot shows a web browser window titled "DIAGNOSTICS" with the address bar set to "http://192.168.1.200". The page content is as follows:

- DIAGNOSTICS** (Section Header)
- Serial Port** (Section Header)
- Table for Serial Port:

Serial Port	Received	Transmitted	
Bytes	10318	7508	<input type="button" value="Reset Counter"/>
- Ethernet Port** (Section Header)
- Table for Ethernet Port:

Ethernet Port	Received	Transmitted	
TCP	8336	6989	<input type="button" value="Reset Counter"/>
UDP	31881	73	<input type="button" value="Reset Counter"/>
ICMP	27	0	<input type="button" value="Reset Counter"/>
- PING** (Section Header)
- Form for PING:

Host IP Address Count

Figure 4.23 iServer DIAGNOSTICS Page

4.5.12.1 Diagnostics - Serial Port

Bytes Received – This is the number of bytes received by the iServer on its serial port.

Bytes Transmitted – This is the number of bytes transmitted by the iServer on the serial port.

The **Reset Counter** button can be clicked and the number of bytes received and transmitted will reset to 0.

4.5.12.2 Diagnostics - Ethernet Port

This section of the webpage provides information about Ethernet packets sent/received by the iServer.

TCP – Received – TCP packets received by the iServer.

TCP – Transmitted – TCP packets transmitted by the iServer.

UDP – Received – UDP packets received by the iServer.

UDP – Transmitted – UDP packets transmitted by the iServer.

ICMP – Received – ICMP packets received by the iServer.

ICMP – Transmitted – ICMP packets transmitted by the iServer.

The **Reset Counter** button can be clicked and the number of bytes received and transmitted (of TCP, UDP or ICMP) will reset to **0**.

4.5.12.3 Diagnostics - Ping

This option can be used to ping a network device and check if it's online or not.

Host IP Address – This represents the IP Address that the device to ping.

Count – This represents the no of times that the iServer will ping the network device.

Note

All the ping packets sent by the iServer need to be replied in order for the iServer to announce the device is alive.

PART 5 SPECIFICATIONS

Serial Interface (-C4EIT)

Interface:	RS422 or RS485 (2-wire)
Connector:	Terminal Block Plugs
Serial Data Rates:	300 to 460,800 bps* <i>*iSeries Controller max is 19,200 bps</i>
Characters:	5, 6, 7, or 8 data bits
Parity:	odd, even, or none
Stop Bits:	1 or 2
Flow Control:	Software (Xon/Xoff) and None

Network Interface

Interface:	Fixed 10BASE-T half duplex Ethernet
Connector:	RJ-45
Protocols:	TCP, UDP, SNMP, SMTP, TFTP, ICMP, Telnet, DHCP, DNS, HTTP, ARP, and Modbus TCP/IP
Compliant to Standard:	IEEE 802.3
Indicators (LED's):	10BASE-T (green) not active, On/Network (green), Serial Transmit Tx (yellow), Serial Receive Rx (green); Power (green)
Processor CPU:	ARM7, 72 MHz
Processor Memory:	512 Kbyte Flash, 32 Kbyte SRAM
Embedded Web Server:	Serves dynamic Web pages and Java applets
Management:	Device configuration and monitoring through Embedded Web Server, Telnet login, Serial login, iConnect

General

Environmental

Operating Temperature:	0 to 50°C (-32 to 122°F), 90%RH non-condensing
Line Voltage/Power:	90 to 240 Vac +/-10%, 50 to 400 Hz* 110 to 375 Vdc, equivalent voltage 4 W , power for i8, i16, iDR Models + Ethernet 5 W , power for i8DV, i8DH, i16D Models + Ethernet <i>* No compliance above 60 Hz</i>

Low Voltage/ Power Option:

20 to 36 Vdc, 4 W
External power source must meet Safety Agency Approvals.
**Units can be powered safely with 24 Vac power but, no Certification for UL are claimed.*

External Fuse Required:	Time-Delay, UL 248-14 listed: 100 mA/250 V 400 mA/250 V (<i>Low Voltage/Power Option</i>) Time-Lag, IEC 127-3 recognized: 100 mA/250 V 400 mA/250 V (<i>Low Voltage/Power Option</i>)
Environmental Conditions:	<ul style="list-style-type: none"> • All models: 0 to 55°C (32 to 131°F), 90% RH non-condensing • i8DV, i8DH, i16D: 0 to 50°C (32 to 122°F) for UL only. 90% RH non-condensing
Protection:	NEMA 4x/Type 4x/IP65 front bezel: i16D NEMA 1/Type 1 front bezel: i8, i8DH, i8DV
Dimensions	i/8 Series: 48 H x 96 W x 127 mm D (1.89 x 3.78 x 5") i/16 Series: 48 H x 48 W x 127 mm D (1.89 x 1.89 x 5")
Panel Cutout:	i/8 Series: 45 H x 92 mm W (1.772" x 3.622"), 1/8 DIN i/16 Series: 45 mm (1.772") square, 1/16 DI
Software:	iConnect Configuration software; iPort COM Port Redirector; iLog (Excel-based software for automatic data logging).
Firmware Upgrade:	Over Ethernet

Refer to the iSeries Manual and Quickstart for complete control functions of iSeries devices with the Embedded Ethernet Server.

**PART 6
FACTORY PRESET VALUES**

PRESET PARAMETERS	FACTORY DEFAULTS
Network Interface:	
DHCP	Disabled
IP Address	192.168.1.200
Subnet Mask	255.255.255.0
Gateway Address	0.0.0.0
DNS Address	0.0.0.0
Host name	eitxxx (x = last 4 digits from the MAC address)
Protocol	TCP
Web Server Port	80
Ethernet Port	10 Mbps, half
Serial Interface:	
Baud Rate	9600
Data Bit	7 bits
Parity	Odd
Stop Bit	1 bit
Flow Control	None
Number of Connections	5
Local Port	2000
End Character	00 (Hex) (Carridge Return)
Buffering Time	500 msec
Packet Length	0 bytes
Inactivity Timeout	0 sec
Disconnect	None
Multi-Host Connection	Disabled

PART 7

APPROVALS INFORMATION

7.1 APPROVALS INFORMATION

This product conforms to the EMC directive 89/336/EEC amended by 93/68/EEC, and with the European Low Voltage Directive 72/23/EEC.

Electrical Safety EN61010-1:2001

Safety requirements for electrical equipment for measurement, control and laboratory.

Double Insulation

Pollution Degree 2

Dielectric withstand Test per 1 min

- Power to Input/Output: 2300 Vac (3250 Vdc)
- Power to Input/Output: 1500 Vac (2120 Vdc)
(Low Voltage dc Power Option*)
- Power to Relays/SSR Output: 2300 Vac (3250 Vdc)
- Ethernet to Inputs: 1500 Vac (2120 Vdc)
- Isolated RS232 to Inputs: 500 Vac (720 Vdc)
- Isolated Analog to Inputs: 500 Vac (720 Vdc)
- Analog/Pulse to Inputs: No Isolation

Measurement Category I

Category I are measurements performed on circuits not directly connected to the Mains Supply (power). Maximum Line-to-Neutral working voltage is 50 Vac/dc. This unit should not be used in Measurement Categories II, III, IV.

Transients Overvoltage Surge (1.2 / 50uS pulse)

- Input Power: 2500 V
- Input Power: 1500 V
(Low Voltage dc Power Option*)
- Ethernet: 1500 V
- Input/Output Signals: 500 V

Note: *Units configured for external low power dc voltage, 20-36 Vdc

EMC:

EN 61326:2006, Class B Emissions

EN 61326:2006, Immunity

EN 55022:2006 + A1:2007, Class B, (CISPR 22 + A1:2005) - Emissions Ethernet

EN 55024:1998 + A1:2001 + A2:2003 - Immunity Ethernet

EN 61000-3-2:2006 AC harmonics Current Emissions

EN 61000-3-3:2008 Voltage Fluctuations and Flickers

Note: ***I/O signal and control lines require shielded cables and these cables must be located on conductive cable trays or in conduits. Furthermore, the length of these cables should not exceed 30 meters*



Refer to the EMC and Safety installation considerations (Guidelines) of this manual for additional information.

7.2 FCC

This device complies with Part 15, Subpart B, Class B of the FCC rules.

Appendix A

GLOSSARY

User of this manual should be familiar with following definitions:

ARP (Address Resolution Protocol) is a protocol for mapping an Internet Protocol address (IP address) to a physical machine address that is recognized in the local network. For example, the IP address in use today is an address that is 32-bits long. In an Ethernet local area network, however, addresses for attached devices are 48-bits long. (The physical machine address is also known as a Media Access Control or MAC address.) A table, usually called the ARP cache, is used to maintain a correlation between each MAC address and its corresponding IP address. ARP provides the protocol rules for making this correlation and providing address conversion in both directions.

Ethernet is a network protocol defined by the IEEE 802.3 standard. Ethernet-based networks use MAC Address rather than IP Address to exchange data between computers. By using ARP and adding TCP/IP support, Ethernet devices may be connected as part of the Internet. An Ethernet LAN typically uses coaxial cable or special grades of twisted pair wires. The most commonly installed Ethernet systems are called 10BASE-T and provide transmission speeds up to 10 Mbps. Devices are connected to the cable and compete for access using a Carrier Sense Multiple Access with Collision Detection (CSMA/CD) protocol.

IP (Internet Protocol) is the method or protocol by which data is sent from one computer to another on the Internet.

IP address (Internet Protocol address) is a 32-bit number that identifies each sender or receiver of information that is sent in packets across the Internet.

IP Netmask is a 32-bit pattern of bits used to determine which part of the IP address is the network portion and which part is the host portion.

MAC (Media Access Control) Address is your computer's unique hardware number. When you're connected to the Internet from your computer, a correspondence table relates your IP address to your computer's physical (MAC) address on the LAN.

Ping is a utility that tests the network connectivity. It is used to determine if the host is capable of exchanging information with another host.

Port number/Socket number is a way to identify a specific process to which an Internet or other network message is to be forwarded when it arrives at a server. It is a predefined address that serves as a route from the application to the Transport layer or from the Transport layer to the application of the TCP/IP system.

Sockets are a method for communication between a client program and a server program in a network and defined as "the endpoint in a connection." Information transferred across the Internet primarily occurs between sockets.

SMTP Simple Mail Transfer Protocol is an Internet standard for electronic mail (email) transfer across the Internet. SMTP clients usually use SMTP to send email messages by specifying the SMTP server. The email server uses SMTP to both send and receive email messages.

SNMP Simple Network Management Protocol is a network monitoring protocol to monitor devices connected to an Ethernet Network.

TCP/IP (Transmission Control Protocol/Internet Protocol) is the basic communication language or protocol of the Internet. When you are set up with direct access to the Internet, your computer is provided with a copy of the TCP/IP program just as every other computer that you may send messages to or get information from also has a copy of TCP/IP. TCP/IP often is used as a general term to indicate generic access to the Internet.

Terminating Resistor is a resistor placed at the extreme end or ends of the RS485 serial cable (across the -Tx/Rx and +Tx/Rx). On one end where the iServer is connected a 120-ohm terminating resistor is built in internally therefore there is no need for termination. However, on the end where the RS485 device is connected, if the device does not have an internal terminating resistor you should connect a 120-ohm resistor across the -Tx/Rx and +Tx/Rx wires (see **Wiring RS485 Interface Section**). Lack of termination can cause data corruption due to electrical noise sensitivity. The value of the terminating resistor is ideally the same value as the characteristic impedance of the cable (typically, 120 ohms for twisted pairs).

Appendix B

IP Address

An IP address is a unique 32-bit address assigned to a computer and includes:

- A network ID number identifying a network.
- A host ID number identifying a computer on the network.

All IP addresses have been divided into three smaller groups (classes) A, B and C

- **Class A** addresses have 8-bits of network ID and 24-bits of host ID. They can support a large number of hosts, approximately $2^{24} = 16,777,216$ computers per network.

The IP addresses range in binary from 00000001.xxxxxxxx.xxxxxxxx.xxxxxxxx
to 01111111.xxxxxxxx.xxxxxxxx.xxxxxxxx

The IP addresses range in decimal from 1.x.x.x to 127.x.x.x

Class A network ID's support a very large number of hosts.

- **Class B** addresses have 16-bits of network ID and 16-bits of host ID. They can support approximately $2^{16} = 65,536$ computers per network.

The IP addresses range in binary from 10000000 00000000.xxxxxxxx.xxxxxxxx
to 10111111 11111111.xxxxxxxx.xxxxxxxx

The IP addresses range in decimal from 128.0.x.x to 191.255.xxx.xxx

Class B network ID's support a medium number of hosts.

- **Class C** addresses have 24-bits of network ID and 8-bits of host ID. They can support approximately $2^8 = 256$ computers per network.

The IP addresses range in binary from 11000000.00000000.00000000.xxxxxxxx
to 11011111.11111111.11111111.xxxxxxxx

The IP addresses range in decimal from 192.0.0.xxx to 223.255.255.xxx

Class C network ID's support a small number of hosts.



The rest of the addresses are divided into two classes, D and E.
Class D networks are not assigned to the host. They are used for multicasting.

The address range from 224.x.x.x to 239.x.x.x

Class E networks are experimental or reserved addresses.
The address range from 240.x.x.x to 247.x.x.x

Appendix C

IP Netmask

IP Netmask or Subnet Mask is a 32-bit pattern of ones and zeros used to determine network portion of an IP address from the host portion of the IP address. Subnet mask is a network ID that is created by borrowing bits from host portion of IP address and using them as part of a network ID. The table below shows a default subnet mask for address Classes A, B, and C. Each bit that is set to "1" in the subnet mask corresponds to the bit in the IP address that is to be used as the network ID. Each bit that is set to "0" in the subnet mask corresponds to a bit in the IP address that is to be used as the host ID.

Address Class	Mask Binary Value	Mask Decimal Value or Dotted Notation
Class A	11111111 00000000 00000000 00000000	255.0.0.0
Class B	11111111 11111111 00000000 00000000	255.255.0.0
Class C	11111111 11111111 11111111 00000000	255.255.255.0

If your network requires more network ID's, you can extend the default subnet mask to include additional bits from the host ID. This allows for additional network ID's within the network. The table below shows some examples of subnet masks and bits moved from the hosts ID to create a new subnet.

Mask Dotted Notation	Mask Binary	Mask Bits
Class A		
255.0.0.0 (Default)	11111111 00000000 00000000 00000000	0
255.192.0.0	11111111 11000000 00000000 00000000	2
255.224.0.0	11111111 11100000 00000000 00000000	3
255.240.0.0	11111111 11110000 00000000 00000000	4
255.248.0.0	11111111 11111000 00000000 00000000	5
255.252.0.0	11111111 11111100 00000000 00000000	6
255.254.0.0	11111111 11111110 00000000 00000000	7
255.255.0.0	11111111 11111111 00000000 00000000	8
255.255.128.0	11111111 11111111 10000000 00000000	9
255.255.192.0.0	11111111 11111111 11000000 00000000	10
.....
255.255.255.252	11111111 11111111 11111111 11111100	22
Class B		
255.255.0.0 (Default)	11111111 11111111 00000000 00000000	0
255.255.192.0	11111111 11111111 11000000 00000000	2
.....
255.255.255.252	11111111 11111111 11111111 11111100	14
Class C		
255.255.255.0 (Default)	11111111 11111111 11111111 00000000	0
255.255.255.192	11111111 11111111 11111111 11000000	2
.....
255.255.255.254	11111111 11111111 11111111 11111100	6

To determine the number of valid hosts ID's remaining after subnetting, use the following equation: $2^n - 2$, where n is the number of octet digits left after the subnet mask.

Appendix D

ASCII Chart

ASCII Char	Dec	Hex	Binary No Parity	ASCII Char	Dec	Hex	Binary No parity
NUL	00	00	00000000	@	64	40	01000000
SOH	01	01	00000001	A	65	41	01000000
STX	02	02	00000010	B	66	42	01000010
ETX	03	03	00000011	C	67	43	01000011
EOT	04	04	00000100	D	68	44	01000100
ENQ	05	05	00000101	E	69	45	01000101
ACK	06	06	00000110	F	70	46	01000110
BEL	07	07	00000111	G	71	47	01000111
BS	08	08	00001000	H	72	48	01001000
HT	09	09	00001001	I	73	49	01001001
LF	10	0A	00001010	J	74	4A	01001010
VT	11	0B	00001011	K	75	4B	01001011
FF	12	0C	00001100	L	76	4C	01001100
CR	13	0D	00001101	M	77	4D	01001101
SO	14	0E	00001110	N	78	4E	01001110
SI	15	0F	00001111	O	79	4F	01001111
DLE	16	10	00010000	P	80	50	01010000
DC1	17	11	00010001	Q	81	51	01010001
DC2	18	12	00010010	R	82	52	01010010
DC3	19	13	00010011	S	83	53	01010011
DC4	20	14	00010100	T	84	54	01010100
NAK	21	15	00010101	U	85	55	01010101
SYN	22	16	00010110	V	86	56	01010110
ETB	23	17	00010111	W	87	57	01010111
CAN	24	18	00011000	X	88	58	01011000
EM	25	19	00011001	Y	89	59	01011001
SUB	26	1A	00011010	Z	90	5A	01011010
ESC	27	1B	00011011	[91	5B	01011011
FS	28	1C	00011100	\	92	5C	01011100
GS	29	1D	00011101]	93	5D	01011101
RS	30	1E	00011110	^	94	5E	01011110
US	31	1F	00011111	_	95	5F	01011111
SP	32	20	00100000	`	96	60	01100000
!	33	21	00100001	a	97	61	01100001
"	34	22	00100010	b	98	62	01100010
#	35	23	00100011	c	99	63	01100011
\$	36	24	00100100	d	100	64	01100100
%	37	25	00100101	e	101	65	01100101
&	38	26	00100110	f	102	66	01100110
'	39	27	00100111	g	103	67	01100111
(40	28	00101000	h	104	68	01101000
)	41	29	00101001	i	105	69	01101001
*	42	2A	00101010	j	106	6A	01101010
+	43	2B	00101011	k	107	6B	01101011
,	44	2C	00101100	l	108	6C	01101100
-	45	2D	00101101	m	109	6D	01101101
.	46	2E	00101110	n	110	6E	01101110

Appendix D**ASCII Chart Continuation**

/	47	2F	00101111	o	111	6F	01101111
0	48	30	00110000	p	112	70	01110000
1	49	31	00110001	q	113	71	01110001
2	50	32	00110010	r	114	72	01110010
3	51	33	00110011	s	115	73	01110011
4	52	34	00110100	t	116	74	01110100
5	53	35	00110101	u	117	75	01110101
6	54	36	00110110	v	118	76	01110110
7	55	37	00110111	w	119	77	01110111
8	56	38	00111000	x	120	78	01111000
9	57	39	00111001	y	121	79	01111001
:	58	3A	00111010	z	122	7A	01111010
;	59	3B	00111011	{	123	7B	01111011
<	60	3C	00111100		124	7C	01111100
=	61	3D	00111101	}	125	7D	01111101
>	62	3E	00111110	~	126	7E	01111110
?	63	3F	00111111	DEL	127	7F	01111111

ASCII Control Codes

ASCII Char	Dec	Hex	Ctrl Key Equiv.	Definition	ASCII Char	Dec	Hex	Ctrl Key Equiv.	Definition
NUL	00	00	Ctrl @	Null Character	DC1	17	11	Ctrl Q	Data Control 1 - XON
SOH	01	01	Ctrl A	Start of Header	DC2	18	12	Ctrl R	Data Control 2
STX	02	02	Ctrl B	Start of Text	DC3	19	13	Ctrl S	Data Control 3 - XOFF
ETX	03	03	Ctrl C	End of Text	DC4	20	14	Ctrl T	Data Control 4
EOT	04	04	Ctrl D	End of Transmission	NAK	21	15	Ctrl U	Negative Acknowledge
ENQ	05	05	Ctrl E	Inquiry	SYN	22	16	Ctrl V	Synchronous Idle
ACK	06	06	Ctrl F	Acknowledge	ETB	23	17	Ctrl W	End of Trans Block
BEL	07	07	Ctrl G	Bell	CAN	24	18	Ctrl X	Cancel
BS	08	08	Ctrl H	Back Space	EM	25	19	Ctrl Y	End of Medium
HT	09	09	Ctrl I	Horizontal Tabulation	SUB	26	1A	Ctrl Z	Substitute
LF	10	0A	Ctrl J	Line Feed	ESC	27	1B	Ctrl [Escape
VT	11	0B	Ctrl K	Vertical Tabulation	FS	28	1C	Ctrl \	File Separator
FF	12	0C	Ctrl L	Form Feed	GS	29	1D	Ctrl]	Group Separator
CR	13	0D	Ctrl M	Carriage Return	RS	30	1E	Ctrl	Record Separator
SO	14	0E	Ctrl N	Shift Out	US	31	1F	Ctrl _	Unit Separator
SI	15	0F	Ctrl O	Shift In	SP	32	20		Space
DLE	16	10	Ctrl P	Data Link Escape					

The iServer may also be assigned an IP Address by using the iConnect software.

- a) Download the iConnect software from the website listed in this manual.
- b) Install iConnect software on a networked PC. This software is compatible with Windows 95, 98, NT, 2000, and XP.
- c) Use iConnect to assign an IP address to the iServer and access its web pages for configuration. You can also use any standard web browser to access the iServer's web pages. Consult with your IT department for obtaining an IP address.

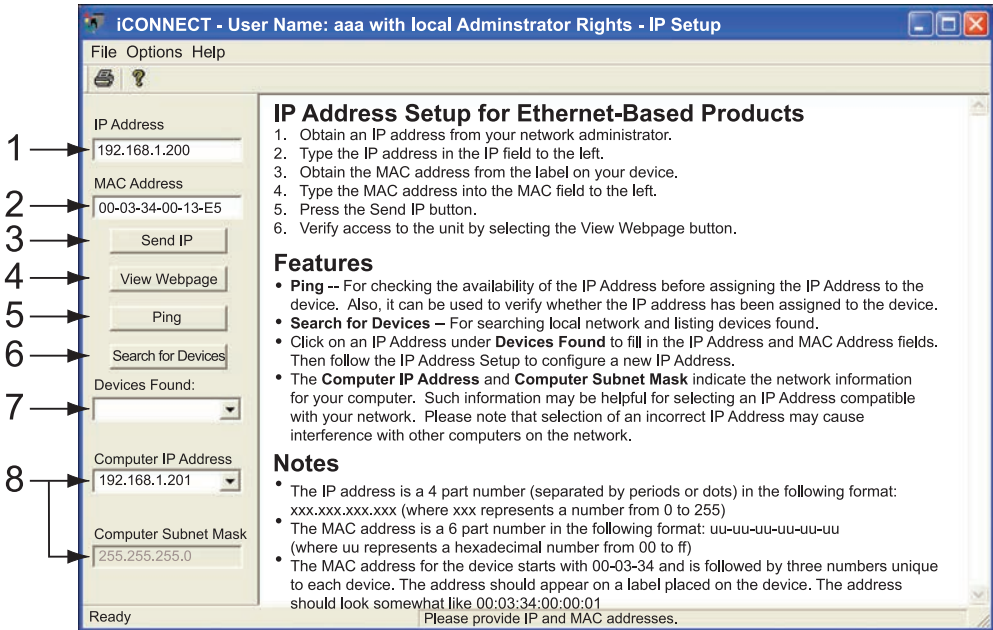

Figure E-1 Assigning an IP Address using iConnect

- 1) Place the IP address in this box.
- 2) Take the MAC address from the label attached to the bottom of the iServer and place it in this box.
- 3) Click here to send the above IP address to the iServer.
- 4) After the IP address is assigned to the iServer, click here to access its web pages.
- 5) Click here to Ping the iServer whose IP address is shown in the IP address box.
- 6) Click here to find all the iServer's on your network .
- 7) The IP addresses for the iServer's found by the iConnect will be listed here.
- 8) These fields indicate the IP address and the subnet mask of the PC on which the iConnect is running.

Appendix E

iConnect Software (continued)

d) To access the iServer for Configuration:

Click on the “View Webpage” button, you will access the iServer’s home page, as shown below.

Refer to **Section 4.4** for more details.



Figure E-2 Accessing the iServer’s HOME Page

Appendix F

HTTPget Program

You can setup and read the information from the iServer by using the HTTPget program. The following program can be used to read data from the embedded server firmware by using TCP port "1000". The command sends this string to TCP port 1000 and reads back the response from the same port. Whatever you write to the port goes to the serial port unmodified. Any response from the serial port can be read back from the same socket.

The HTTPget.exe file is used to setup and read information from the iServer. This file is available on our website.

Example to use the HTTPget program:

1. Create a directory **C:\iServer\HTTPget**
2. Copy HTTPget.exe and readme_features.doc files to this directory.
3. Make sure that you are in this directory and then enter the following test program:
4. For help, execute HTTPget.exe

```
C:\iServer\httpget>httpget -r -S "*01X01\r" 192.168.1.200:1000
```

where:

-r -S	are parameters needed for the command string
*01	is device address (in hex format) for RS485 (-C4EIT) communication interface (skip for embedded ethernet (-EIT))
X01	read measurement data value (iSeries protocol)
\r	is the carriage return termination character
192.168.1.200	is an IP address
1000	is a local port number

Response:

```
01X01074.3
```

where:

01X01	is Echo command
074.3	is a display reading of the 4-digit device



In the example above the 4-digit iSeries controller has been connected to the serial communication port of iServer.

Appendix F

HTTPget Program (continued)

```
C:\iServer>httpget -r -S "*"02X01\r" 192.168.1.200:2000
```

```
02X01263.1
```

```
C:\iServer>
```

Note See the data on the console if the disconnect checkbox is “checked”.

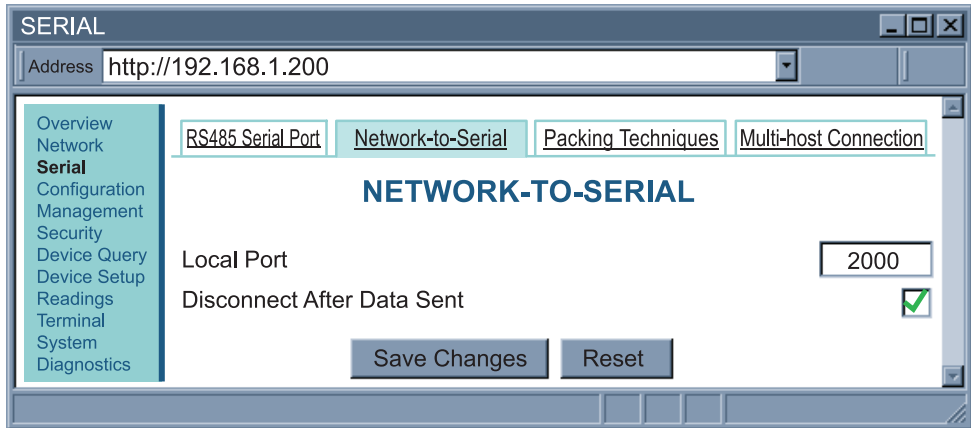

Figure F-1 iServer SERIAL Page – Network to Serial

If the “Disconnect After Data Sent” is unchecked, the cursor will stay with no line feed

```
C:\iServer>httpget -r -S "*"02X01\r" 192.168.1.200:2000
```

```
02X01262.9
```

Until time out by the httpget (aprox.24sec)

```
C:\iServer>httpget -r -S "*"02X01\r" 192.168.1.200:2000
```

```
Network read timeout.
```

```
C:\iServer>
```

Or you can specify the disconnection with the switch –C seconds)

You will see the “data” and then the warning message of Network time out

```
C:\LAB>httpget -r -S "*"02X01\r" 192.168.1.200:2000 -C 5
```

```
Network read timeout.
```

```
C:\iServer>
```

ARP is the Internet layer protocol responsible for matching or obtaining the MAC (hardware) address that corresponds to a particular IP address. The ARP command allows the user to view the current contents of the ARP cache of the local computer (residing on the same network) or remote computer (residing on the different network) through a router.

Microsoft includes the ARP.EXE utility for viewing and modifying the ARP cache with its Windows products. The following ARP commands can be used to view cache entries:

- **arp -a** → Use this command to view all ARP cache entries.
- **arp -a** plus **IP address** → Use this command to view ARP cache entries associated with one particular interface on a network with multiple adapters.
- **arp -g** → Same as **arp -a**.
- **arp -N** → Use this command to display ARP entries for specific network interface.
- **arp -s** plus **IP address** plus **Physical address** → Use this command to manually add a permanent static entry to the ARP cache.
- **arp -d** → Use this command to manually delete a static entry.

Note

Ping the destination computer using IP address first before using the **arp -a** command.

The following window shows examples of arp commands and responses.

- Your computer has an IP address of **192.168.1.118**
- The destination computer has an IP address of **192.168.1.96**

```

MS-DOS Prompt
Auto
C:\>arp - 192.168.1.96
No ARP Entries Found
C:\>ping 192.168.1.96
Pinging 192.168.1.96 with 32 bytes of data:

Reply from 192.168.1.96=bytes=32 time=5ms TTL=32
Reply from 192.168.1.96=bytes=32 time=3ms TTL=32
Reply from 192.168.1.96=bytes=32 time=3ms TTL=32
Reply from 192.168.1.96=bytes=32 time=4ms TTL=32

C:\>arp -a 192.168.1.96
Interface: 192.168.1.118
    Internet Address  Physical Addresss  Type
    192.168.1.96      00-03-34-00-00-23  dynamic
C:\>arp -s 192.168.1.96 00-03-34-00-00-23
C:\>arp -a 192.168.1.96
Interface: 192.168.1.118
    Internet Address  Physical Addresss  Type
    192.168.1.96      00-03-34-00-00-23  static
C:\>arp -d 192.168.1.96
C:\>arp -a 192.168.1.96
No ARP Entries Found
C:\>
  
```

Figure G-1 ARP Commands and Responses

Appendix H

Telnet Setup

Telnet stands for Telecommunications Network, it is a protocol that provides a way for users (or clients) to connect to computers (or servers) on a network, whether in the next building or across the other side of the world.

You can open a Telnet session using other terminal emulation programs like Tera Term Pro (downloadable from the internet), which is a free software for MS-Windows. It supports VT100 emulation, Telnet connection and serial port connection.

Once the Telnet mechanism is decided we can open a session by simply typing the IP address of the iServer, and setting the Port on **2002** for logging into the iServer Configuration page, or **2000** for accessing the serial device connected to the iServer's serial port.

Admin Port 2002

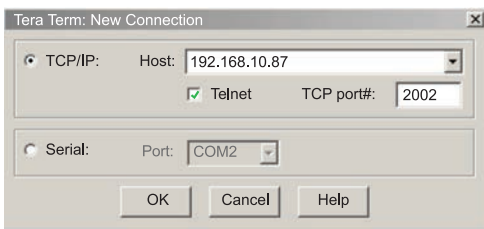

Figure H-1

Tera Term Telnet Connection Screen

Parameters

```
Administrator Password?00000000
iSeries >p

Model:                iSeries-EIT
Firmware Ver:

BD:  9600 (6)
DT:  7 bits (3)
PT:  Odd (3)
ST:  1 bit (1)
FC:  None (1)
DP:  Disabled (0)
MC:  00:03:34:00:D9:A2
IP:  192.168.10.87
SM:  255.255.255.0
GW:  192.168.10.50
LP:  12345678
SP:  00000000
CP:
TC:  Enabled (1)
WS:  Enabled (1)

iSeries>
```

Figure H-2 Telnet Setup



The default password for Telnet Login is 00000000 and can be changed if desired.

In the Configuration mode you can make any changes just like you would using the Web Browser. After connected to the iServer, the user can use the following commands to read, modify, and get help from the iServer console.

- p** Following with a return character, the console will show the iServer configurations (**Figure H-1**).
- ?** Following with a return character, the console will show all the commands and options (**Figure H-2**).

Appendix H

Telnet Setup (continued)

- s** Is the configuration command, used to set a new setting (see the example in **Figure I-3**)
- RESET** Following with a return character, it will recycle the Power on the iServer.
- FACTORY** Following with a return character, it will set the iServer to it's factory default settings.
- c** The current settings will be stored permanently .
- q** quit

```
Administrator Password?00000000
iSeries>?
Available Commands:
1. RESET (To reboot the device)
2. FACTORY (To restore factory defaults)
3. ? (Help/This screen)
4. c (confirm settings and write to the flash)
5. p (Print the settings)
6. q (Quite this console)
7. s-<ARG><VALUE> (To change device settings)
+-----+
| Arg | Description | Value |
+-----+
| BD | BaudRate | 1-300, 2-600, 3-1200,
| | | 4-2400, 5-4800, 6-9600,
| | | 7-19200, 8-38400
| | | 9-57600, 10-115200,
| | | 11-230400, 12-460800
| DT | Data Bits | 1-5 bits, 2-6 bits,
| | | 3-7 bits, 4-8 bits
| PT | Parity | 1-none, 2-even, 3-odd
| ST | Stop Bit | 1-1 bit, 2-2 bits
| FC | FlowControl | 1-none, 2-hw, 3-sw
| DP | DHCP | 0-Disable, 1-Enable
| IP | IP address |
| SM | Subnet mask |
```

GW	Gateway		
DN	DNS server address		
LP	Login password	0-16 Alphanumeric chars	
SP	Admin password	0-16 Alphanumeric chars	
PP	Local port password	0-16 Alphanumeric chars	
TC	Telnet console access	0-Disable, 1-Enable	
WS	webserver access	0-Disable, 1-Enable	
SR	Secured readings, Charts	0-Disable, 1-Enable	
+-----+			
Example:			
To configure Baudrate 9600, 1 stop bit, Odd Parity, and RS232 m			
s -BDS -PT1 -ST1 MDO			
iSeries>			

Figure H-3 Telnet Setup - iServer Help Page

Appendix I Remote Access (Tunneling)

To "tunnel", in this context, is to transmit data between two points through a private conduit on a shared or public network. The network could be an Ethernet LAN, a WAN, or the Internet. The iServer allows for a connection between a serial device and a PC, or between two serial devices, using an existing network rather than dedicated wiring.

Today, there are number of serial devices like sensors, gauges, PLCs, card readers, security alarms, barcode scanners, data loggers, video cameras, ATM machines, time & attendance terminals, medical lab equipments, electronic signboards, and many others that are directly connected to PCs via their serial ports. These devices can be attached to shared Ethernet networks (TCP/IP protocol) and get accessed, controlled, and managed remotely using the iServer products.

Any two iServer's can talk to each other over the Ethernet LAN, WAN, and Internet using TCP/IP protocol. Therefore, the connected serial devices to iServer's can also communicate with each other back and forth over these networks. This characteristic is called Tunneling and it's illustrated in **Figures I.1 and I.2.**

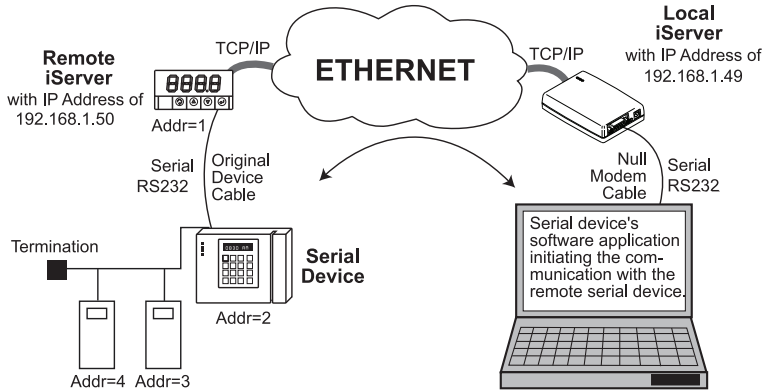

Figure I-1a Serial Tunneling - iSeries -C4EIT

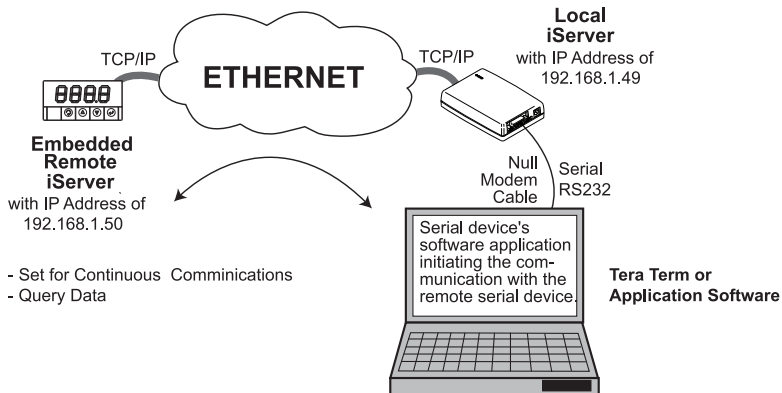

Figure I-1b Serial Tunneling - iSeries -EIT

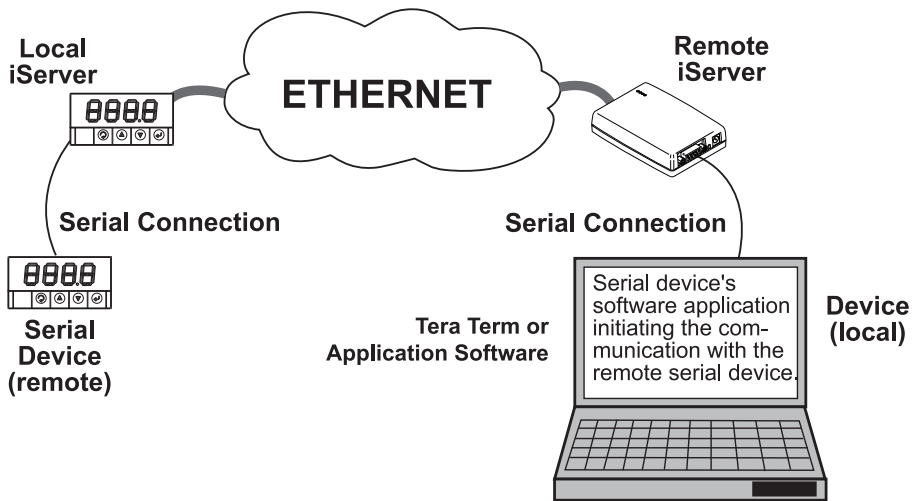

Figure I-2 Device-to-Device Communication

In order to use this Tunneling feature, some settings are required within the local and remote iServer's.

I-1 Remote iSeries -EIT/-C4EIT

It's recommended to configure the Remote iServer and have it up and running before the Local iServer is configured.

1. A static IP address must be assigned to the Remote iServer. This means that the DHCP must remain disabled.
Refer to the DHCP section of the user's manual for details.
2. Use a browser to access the Remote iServer's WEB page. Simply type the iServer's IP address at the browser's URL location (i.e. **192.168.1.50**) followed by an **Enter** key. You should then see the iServer's main WEB page.
3. Click on the OK button after entering the LOGIN password.
4. On the SERIAL page, under *Serial Port* section (see **Figure 4.6** or **4.7**) make sure the parameters: **Baud Rate**, **Data Bits**, **Parity**, **Stop Bits**, and **Flow Control** match the serial communication settings of your attached serial device.
5. Under *Packing Techniques* section (see **Figure 4.8**) make sure to set the **End Character (Hex)** to **00** and the **Buffering Time** is set to **0**.
6. If Data is too fast, try setting the iSeries-EIT in continuous mode to 0-500 ms, so that the local connection has time to respond.
6. Click on **Save** button for the changes to take place.

Make sure that the serial cable and communication settings between the iServer and the serial device are valid.

Appendix I Remote Access (Tunneling) (continued)

I-2 Local iSeries -EIT/-C4EIT

1. An IP address should be assigned to the iServer dynamically or statically (recommended).
2. Use a browser to access the Local iServer's WEB page. Simply type the iServer's IP address at the browser's URL location (i.e. **192.168.1.49**) followed by an **Enter** key. You should then see the iServer's main WEB page.
3. Click on the OK button after entering the LOGIN password.
4. Click on NETWORK page, you will be prompted with a Password (default is 00000000).
5. On the SERIAL page, under *Serial Port* section (see **Figure 4.6** or **4.7**), make sure the parameters: **Baud Rate**, **Data Bits**, **Parity**, **Stop Bits**, and **Flow Control** match with your attached serial device and its application software.
6. Under *Packing Techniques* section (see **Figure 4.8**), make sure to set the **End Character (Hex)** to **00** and the **Buffering Time** to **0**.
7. Under *Multi-host* section (see **Figure I-3**), set the **Connection Type** to **Simultaneous/ Sequential**, enter the **Remote IP address** (would be the IP address of the remote iServer, 192.168.1.50), and use the default **Remote Port** number **2000**.

Set **Retry Counter** to anything more than **0** and set the **Retry Timeout** to a desired value.

If the tunneling connection between the two iServers goes down due to network problems, power failure, etc., the *Sequential* connection type option will enable the Local iServer to reconnect with the Remote iServer based on the specified time interval in the Retry Timeout.

For example, based on a timeout of 10000 (10 seconds), the Local iServer will continually attempt to reconnect and reestablish the tunnel with the Remote iServer every 10 seconds.

9. Click on **Save** button for the changes to take place.



When setting the iSeries -EIT/-C4EIT as a Remote iServer, reboot the unit for the settings to take place.

When setting the iSeries -EIT/-C4EIT as a Local iServer, only the iSeries -C4EIT has RS485 serial connection.

10. Initialize the serial device application software to establish the connection.

Appendix I Remote Access (Tunneling) (continued)

I-2 Local iSeries -EIT/-C4EIT (continued)

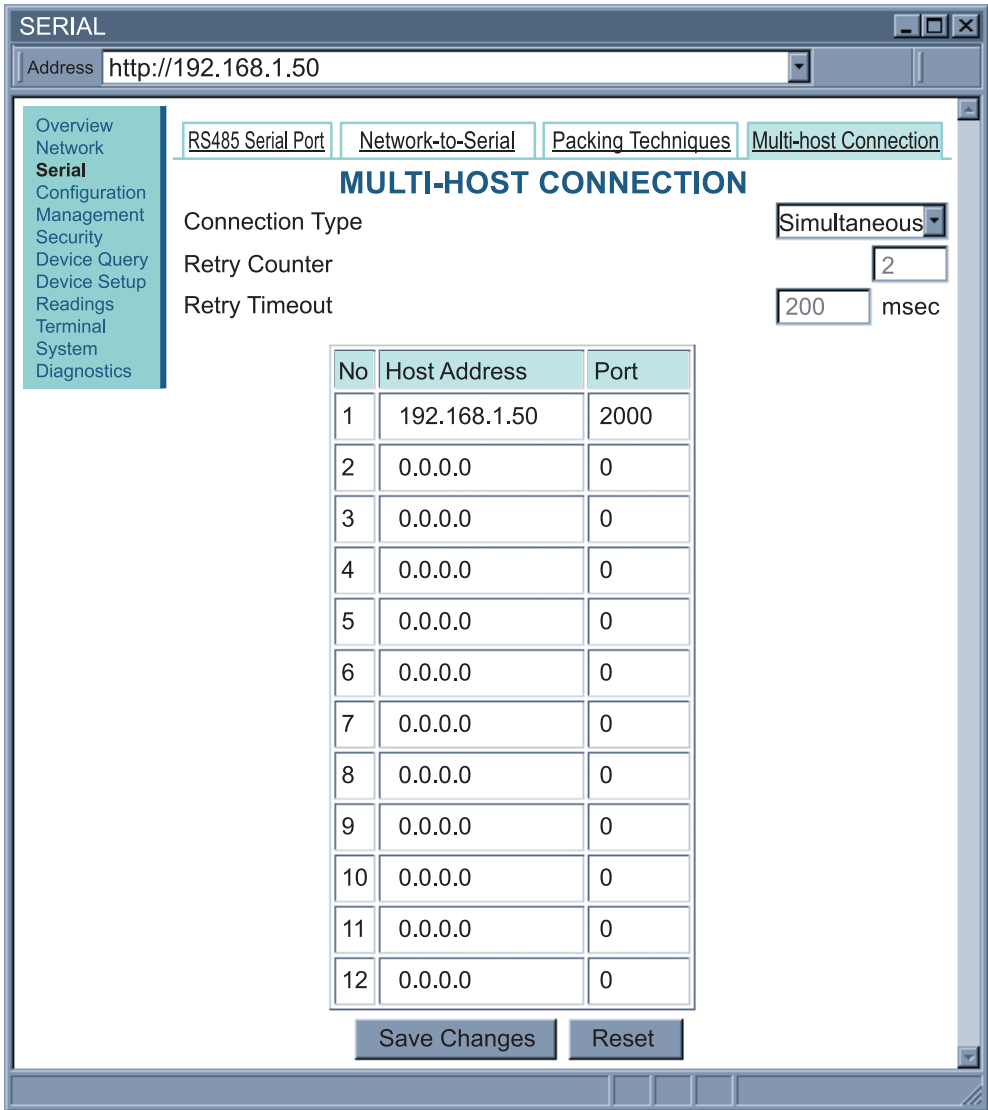

Figure I-3 SERIAL - Multi-Host Connection (-C4EIT)

Appendix I Remote Access (Tunneling) (continued)

I-3 Tunneling Troubleshooting

Using the original serial cable, please confirm valid communication between the serial device and its application software on the PC with no iServers in between (direct serial connection). Otherwise, reset the power, first on the remote iServer and then on the local iServer and recheck for Connection type drop down menu as simultaneous.

A quick way to check the LAN and serial tunneling connection is to separately access each iServer WEB page via the Ethernet. If successful, this should prove a valid LAN connection.

For serial tunneling, open a HyperTerminal session on the PC pointing to the same COM port to which the Local iServer is connected and type/send some characters. This should cause the **Rx Receive** LED on the Local iServer to blink as it receives the data from the serial port and onto the LAN. Accordingly, the **Tx Transmit** LED on the Remote iServer should blink as it transmits the data from the LAN into the serial device. If no LEDs blink, then that could possibly point to the iServer connection in trouble - particularly, the serial cabling and/or the serial settings (Baud rate, stop bit, parity, etc.) throughout the communication path between the PC, the iServer, and the serial device.

J-1 iPORT, COM Port Redirector

To obtain the iPORT software (iPORT.exe file) please use the phone number, as listed on the cover of this manual, to contact the Sales Department nearest you.

To install the iPORT application, simply double-click on the iPORT.exe file and follow the installation steps. The iPORT is compatible with Windows NT, 2000, XP and Windows 7 (32 or 64-bit) operating systems.

J-2 iPORT Overview

The iPORT is a COM port redirecting software. Its function is to redirect connections that are destined for a local serial (COM) port on a PC, to an iServer network-enabling device on the LAN.

In a direct serial connection, application software can communicate directly over an RS232 or RS485 with a serial device (**Figure J-1**).

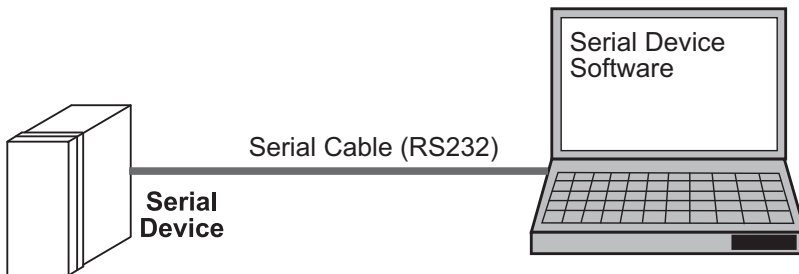

Figure J-1 Direct Serial Connection

By installing iPORT software on the same PC, the iPORT will redirect the serial connection from the COM port to the network port on that PC. The connection can simply reach the serial device through an iServer sitting anywhere on an Ethernet network (**Figure J-2**).

J-2 iPORT Overview (continued)

This connection redirection is totally transparent to the serial device and its application software. Once the connection is up from the PC to the serial device, the data is transmitted across the Ethernet network to the serial device and back from the serial device to the PC, all through the iServer and the iPORT.

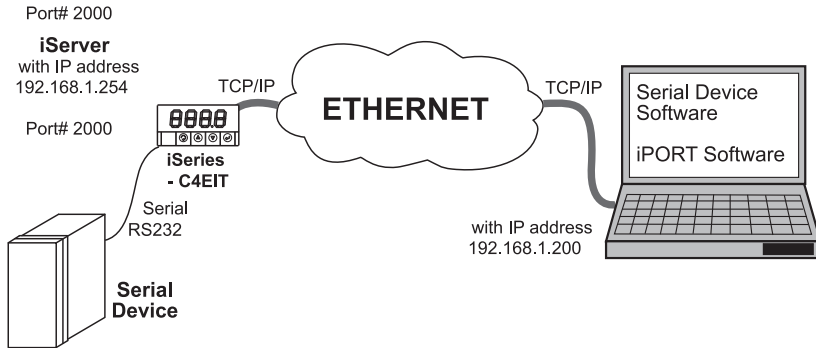

Figure J-2a Redirect Serial Connection

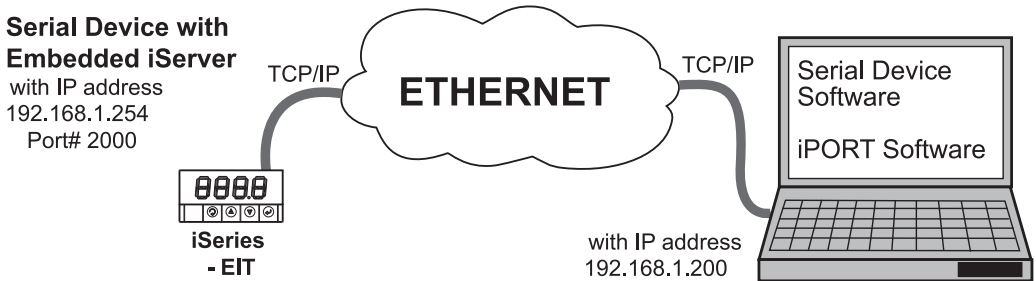

Figure J-2b Redirect Serial Connection - Embedded PCB iServer

J-3 iPORT Configurations

After the iPORT is successfully installed on your windows machine, you will have an iPORT icon on your desktop and Control Panel window. By double-clicking on this icon, you can start the application and the iPORT main window will appear on your screen, see **Figure J-3**.

Click on "COM Ports" button and you will see the window shown in **Figure J-4**. Select the appropriate COM port (this should be the same COM port that your application software uses). The selected COM port will then appear on the main iPORT window. By highlighting the selected COM port, you will be able to add the IP address and the port number to connect that COM port to the iServer on the network.

Up to 255 COM ports can be selected and each can have a different IP configuration pointing to different iServers on the network. This enables users to simultaneously redirect different application software to connect to serial devices attached to networked iServers.

J-3 iPORT Configurations (continued)

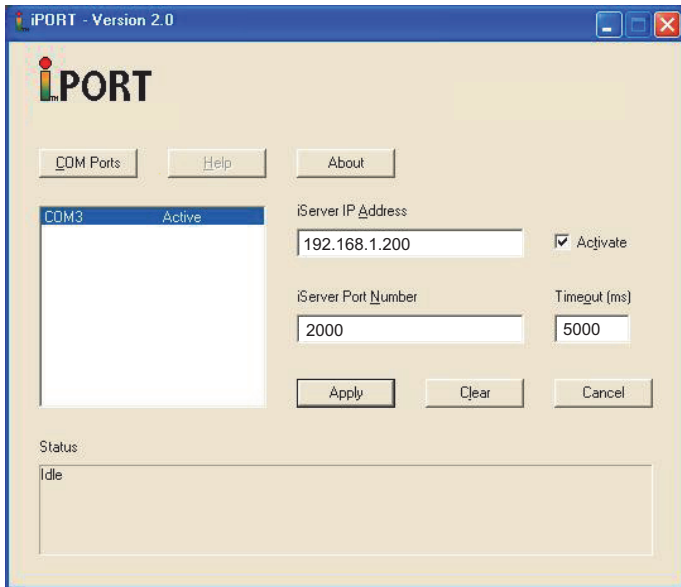

Figure J-3 iPORT Main Window

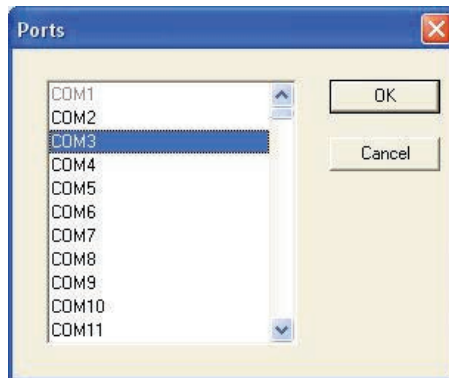

Figure J-4 COM Port Window

iServer IP Address – This is the IP address of the iServer that is connected to the serial device on one end and attached to the Ethernet LAN on the other end. The iServer’s default IP address is **192.168.1.200**, which can be changed to fit your network IP address range (see **Section 4**).

iServer Port Number – This is the port number for the iServer’s local serial port. The default value is 2000. If this port number is changed in the iServer’s Configuration page (see **Section 4.5.4.1**), the same number should be placed in the iPORT window.

J-3 iPORT Configurations (continued)

Activate – If this box is checked, the selected COM port will be available for network connection. If it is unchecked, the selected COM port will be in sleep mode.

Timeout – This is the amount of time (in milliseconds) in which the iPORT keeps the application software waiting before the device response is arrived. The default value is 5 seconds and it can be set between 0 to 10 seconds.

Status – This window shows the connection status as the iPORT makes connection to the iServer or disconnects from the iServer. The connection status can be ideal, connecting, connected, or disconnected along with the IP address of the iServer shown in the Status window.

Apply button – To save the configuration for a selected COM port, click on the "Apply" button and reboot your PC for settings to take place in your Windows registry.

Clear button – This button deletes the settings for a selected COM port.

Cancel button – This button closes the iPORT window without saving the settings.

In **Figure J-3**, if a COM port number is dimmed and cannot be selected, it means that the COM port is already used by another application or it could be a physical serial COM port on that PC.

**Note**

The serial communication settings (baud rate, data bit, stop bit and parity) of your application software must be identical to the serial communication settings of the iServer's serial port and your serial device's port connected to the iServer. You can use a Web browser to log

Appendix K

iLog Software

The iLog Software can only be used with our brand of instruments. For complete information of how to use the iLog software, click on the Help menu of the main window.

This is an Excel application software that can log values from the serial device over the local network (Ethernet) or the internet.

- a) Download the iLog software from the website listed on the cover of this manual.
- b) Install iLog software on a networked PC. This software is compatible with Windows 95, 98, NT, 2000, XP, Windows Vista and Windows 7 (32 and 64-bit).
- c) If you have Excel 2007 or higher, when installing iLog choose “Custom” installation option and on the next window check the box for “Excel 2007 Apps” and continue the installation to the end.
- d) For complete information of how to use the iLog software, click on the HELP button.
- d) There is a list of Error Messages, see **Table K-2**.

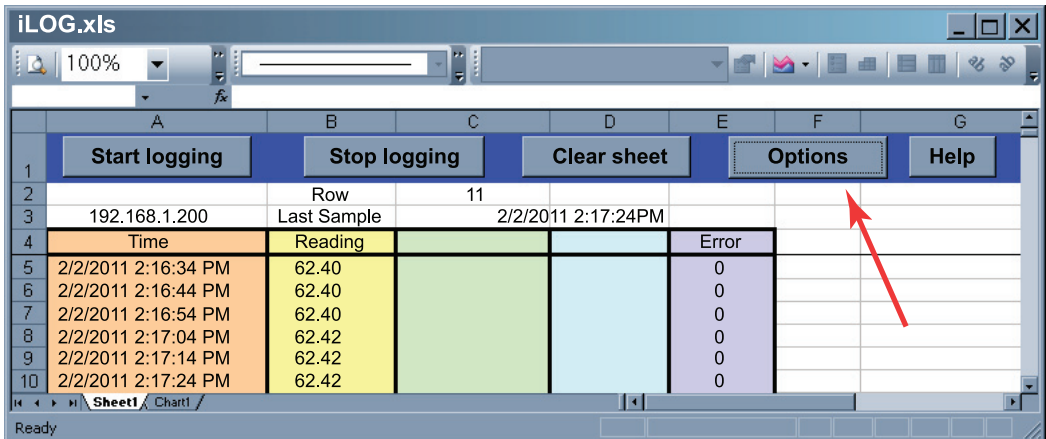

	A	B	C	D	E	F	G
1	Start logging	Stop logging	Clear sheet	Options	Help		
2		Row	11				
3	192.168.1.200	Last Sample	2/2/2011 2:17:24PM				
4	Time	Reading			Error		
5	2/2/2011 2:16:34 PM	62.40			0		
6	2/2/2011 2:16:44 PM	62.40			0		
7	2/2/2011 2:16:54 PM	62.40			0		
8	2/2/2011 2:17:04 PM	62.42			0		
9	2/2/2011 2:17:14 PM	62.42			0		
10	2/2/2011 2:17:24 PM	62.42			0		

Figure K-1 iLog Software Logging Data for an iSeries

Note

The Options button will let you select the product model. Choose your device type from the Model Selection pull-down menu (from General tab).

Table K-1 iLog Excel Applications

The iLog application actually consists of several Excel files, though most supported devices can be accessed by the main iLog program. The main program is listed as "iLog", plus a version number, under the Start Menu program links (those links available by clicking the Start button on the Windows taskbar).

In the following table, the iLog File column shows how many sensors are logged by the main iLog file. If more than 3 sensors are available, then the Alternate column shows how many sensors the device can support. Devices with more than 3 sensors will have their own Excel file. For these files, click on the model device found in the Start Menu.

Networked Product	iLOG File	Alternate
iTHX-W, iTHX-2	3 column	
iTHX-M, iTHX-SD	3 column	
iTHX-W Dual Probe	1st probe / 3 column	6 column
iSE-TC, iSD-TC	3 column	5 column
iSE-TH, iSD-TH	3 column	5 column
iBTHX-W, iBTHX-D	3 column	4 column
iBTX-M, iBTX-SD	2 column	
iPTX-W	2 column	
iTCX	3 column	
iTH Controller	3 column	
iVI	3 column	4 column
iSeries	1 column	
iDRX/iDRN	1 column	
INF-B	1 column	

Wireless Devices

The "Auto" column shows number of columns per remote device that are possibly displayed.

The Full column shows number of columns allocated per device for the "Full" spreadsheet, which will be able to display all data for all active devices.

Networked Product	Auto	Full
zSeries Receiver and Remotes	1 to 4 column / device	4 column / 32 device
zSeries with zED Remotes	1 to 2 column / device	2 column / 32 device
UWTC REC-3 and Remotes	1 or 2 column / device	2 column / 32 device
zSeries with UWTC Remotes	1 to 2 column / device	2 column / 32 device

The active wireless devices, when shown in the Excel application, will be shown with the device number and the units returned.

Appendix K**iLog Software (continued)**

The iLog Software can only be used with our brand of instruments.

Table K-2 iLog Error Messages

Error #	Description	Note
-8003	User stopped logging readings.	
-10005	Failed to find the iServer.	Ethernet cable is disconnected, iServer is powered off, connections across the firewall require longer "connection to socket time out" setting.
-10006	Windows socket was closed.	
-10007	Windows socket error.	Wrong IP or wrong Port number was used.
-10008	The iServer failed to respond to a request.	Wrong IP or wrong Port number was used.
-10011	Response came empty.	No data was sent.
-10012	Device responded with "Serial Time Out" string.	Possibly the iLog is configured for wrong product model.
-10014	Terminal Server Mode when the Port is 1000.	Try Port 2000 in iLog configuration.
-15100	Error on obtaining the temperature reading.	Possibly the iLog is configured for wrong product model.

WARRANTY/DISCLAIMER

OMEGA ENGINEERING, INC. warrants this unit to be free of defects in materials and workmanship for a period of **one (1) year** from the date of purchase. In addition to OMEGA's standard warranty period, OMEGA Engineering will extend the warranty period for **four (4) additional year** if the warranty card enclosed with each instrument is returned to OMEGA.

If the unit malfunctions, it must be returned to the factory for evaluation. OMEGA's Customer Service Department will issue an Authorized Return (AR) number immediately upon phone or written request. Upon examination by OMEGA, if the unit is found to be defective, it will be repaired or replaced at no charge. OMEGA's WARRANTY does not apply to defects resulting from any action of the purchaser, including but not limited to mishandling, improper interfacing, operation outside of design limits, improper repair, or unauthorized modification. This WARRANTY is VOID if the unit shows evidence of having been tampered with or shows evidence of having been damaged as a result of excessive corrosion; or current, heat, moisture or vibration; improper specification; misapplication; misuse or other operating conditions outside of OMEGA's control. Components which wear are not warranted, including but not limited to contact points, fuses, and triacs.

OMEGA is pleased to offer suggestions on the use of its various products. However, OMEGA neither assumes responsibility for any omissions or errors nor assumes liability for any damages that result from the use of its products in accordance with information provided by OMEGA, either verbal or written. OMEGA warrants only that the parts manufactured by it will be as specified and free of defects. OMEGA MAKES NO OTHER WARRANTIES OR REPRESENTATIONS OF ANY KIND WHATSOEVER, EXPRESS OR IMPLIED, EXCEPT THAT OF TITLE, AND ALL IMPLIED WARRANTIES INCLUDING ANY WARRANTY OF MERCHANTABILITY AND FITNESS FOR A PARTICULAR PURPOSE ARE HEREBY DISCLAIMED. LIMITATION OF LIABILITY: The remedies of purchaser set forth herein are exclusive, and the total liability of OMEGA with respect to this order, whether based on contract, warranty, negligence, indemnification, strict liability or otherwise, shall not exceed the purchase price of the component upon which liability is based. In no event shall OMEGA be liable for consequential, incidental or special damages.

CONDITIONS: Equipment sold by OMEGA is not intended to be used, nor shall it be used: (1) as a "Basic Component" under 10 CFR 21 (NRC), used in or with any nuclear installation or activity; or (2) in medical applications or used on humans. Should any Product(s) be used in or with any nuclear installation or activity, medical application, used on humans, or misused in any way, OMEGA assumes no responsibility as set forth in our basic WARRANTY/DISCLAIMER language, and, additionally, purchaser will indemnify OMEGA and hold OMEGA harmless from any liability or damage whatsoever arising out of the use of the Product(s) in such a manner.

RETURN REQUESTS/INQUIRIES

Direct all warranty and repair requests/inquiries to the OMEGA Customer Service Department. **BEFORE RETURNING ANY PRODUCT(S) TO OMEGA, PURCHASER MUST OBTAIN AN AUTHORIZED RETURN (AR) NUMBER FROM OMEGA'S CUSTOMER SERVICE DEPARTMENT (IN ORDER TO AVOID PROCESSING DELAYS).** The assigned AR number should then be marked on the outside of the return package and on any correspondence.

The purchaser is responsible for shipping charges, freight, insurance and proper packaging to prevent breakage in transit.

FOR WARRANTY RETURNS, please have the following information available BEFORE contacting OMEGA:

1. Purchase Order number under which the product was PURCHASED,
2. Model and serial number of the product under warranty, and
3. Repair instructions and/or specific problems relative to the product.

FOR NON-WARRANTY REPAIRS, consult OMEGA for current repair charges. Have the following information available BEFORE contacting OMEGA:

1. Purchase Order number to cover the COST of the repair,
2. Model and serial number of product, and
3. Repair instructions and/or specific problems relative to the product.

OMEGA's policy is to make running changes, not model changes, whenever an improvement is possible. This affords our customers the latest in technology and engineering.

© Copyright 2013 OMEGA ENGINEERING, INC. All rights reserved. This document may not be copied, photocopied, reproduced, translated, or reduced to any electronic medium or machine-readable form, in whole or in part, without the prior written consent of OMEGA ENGINEERING, INC.

TRADEMARK NOTICE:  [®], omega.com[®],  **OMEGA**[®], and  are Trademarks of OMEGA ENGINEERING, INC.

PATENT NOTICE: This product is covered by one or more of the following patents: U.S. Pat. No. Des. 336,895; 5,274,577/ CANADA 2052599; 2052600 / ITALY 1249456; 1250938 / FRANCE BREVET No. 91 12756 / SPAIN 2039150; 2048066 / UK PATENT No. GB2 249 837; GB2 248 954 / GERMANY DE 41 34398 C2. Other US and International Patents pending or applied for.

Where Do I Find Everything I Need for Process Measurement and Control? **OMEGA...Of Course!** *Shop on line at omega.com*

TEMPERATURE

- Thermocouple, RTD & Thermistor Probes, Connectors, Panels & Assemblies
- Wire: Thermocouple, RTD & Thermistor
- Calibrators & Ice Point References
- Recorders, Controllers & Process Monitors
- Infrared Pyrometers

PRESSURE, STRAIN AND FORCE

- Transducers & Strain Gauges
- Load Cells & Pressure Gauges
- Displacement Transducers
- Instrumentation & Accessories

FLOW/LEVEL

- Rotameters, Gas Mass Flowmeters & Flow Computers
- Air Velocity Indicators
- Turbine/Paddlewheel Systems
- Totalizers & Batch Controllers

pH/CONDUCTIVITY

- pH Electrodes, Testers & Accessories
- Benchtop/Laboratory Meters
- Controllers, Calibrators, Simulators & Pumps
- Industrial pH & Conductivity Equipment

DATA ACQUISITION

- Data Acquisition & Engineering Software
- Communications-Based Acquisition Systems
- Plug-in Cards for Apple, IBM & Compatibles
- Datalogging Systems
- Recorders, Printers & Plotters

HEATERS

- Heating Cable
- Cartridge & Strip Heaters
- Immersion & Band Heaters
- Flexible Heaters
- Laboratory Heaters

ENVIRONMENTAL MONITORING AND CONTROL

- Metering & Control Instrumentation
- Refractometers
- Pumps & Tubing
- Air, Soil & Water Monitors
- Industrial Water & Wastewater Treatment
- pH, Conductivity & Dissolved Oxygen Instruments