



# Thunder K7

## S2462

### User's Manual

#### Revision 1.00

Copyright © Tyan Computer Corporation, 2001. All rights reserved. No part of this manual may be reproduced or translated without prior written consent from Tyan Computer Corp.

All registered and unregistered trademarks and company names contained in this manual are property of their respective owners including, but not limited to the following.

Tyan, Thunder K7 S2462 are trademarks of Tyan Computer Corporation.  
AMD, 760MP, Athlon are registered trademarks of Advanced Microdevices, Inc.  
Phoenix, Phoenix BIOS are trademarks of Phoenix Software.  
Microsoft, Windows are trademarks of Microsoft Corporation.  
IBM, PC, AT, PS/2 are trademarks of IBM Corporation.  
QLogic, Zircon are trademarks of QLogic Corporation.  
Winbond is a trademark of Winbond Electronics Corporation.  
ATI, Rage XL are trademarks of ATI Technologies, Inc.  
Adaptec is a registered trademark of Adaptec, Inc.  
Micronics is a trademark of Micronics Corporation.  
Iomega, Zip are registered trademarks of Iomega Corporation.

Information contained in this document is furnished by Tyan Computer Corporation and has been reviewed for accuracy and reliability prior to printing. Tyan assumes no liability whatsoever, and disclaims any express or implied warranty, relating to sale and/or use of Tyan products including liability or warranties relating to fitness for a particular purpose or merchantability. Tyan retains the right to make changes to product descriptions and/or specifications at any time, without notice. In no event will Tyan be held liable for any direct or indirect, incidental or consequential damage, loss of use, loss of data or other malady resulting from errors or inaccuracies of information contained in this document.

# Table of Contents

<b>Before you begin...</b>	<b>Page 4</b>
<b>Chapter 1: Introduction</b>	<b>5</b>
1.1	Congratulations! .....5
1.2	Thunder K7 System Block Diagram .....6
1.3	Hardware Specifications .....7
1.4	Software Specifications .....8
<b>Chapter 2: Board Installation</b>	<b>9</b>
2.1	Installation .....9
2.2	How to install our products right... the first time .....9
2.3	Here are some safety tips .....9
2.4	Quick Reference for Jumpers .....10
2.5	Map of Motherboard Jumpers .....11
2.6	Setting up Jumpers and Onboard Connectors .....12
2.6-A	Front Panel Connector .....12
2.6-B	CMOS Reset .....12
2.6-C	CPU Front Side Bus Jumpers .....13
2.6-D	Onboard LAN Enable/Disable .....13
2.6-E	Onboard SCSI Enable/Disable .....14
2.6-F	Onboard Video Enable/Disable .....14
2.6-G	Serial Port 2 .....15
2.6-H	LAN LED Header .....15
2.6-I	USB Header .....16
2.6-J	FAN Headers .....16
2.6-K	Chassis Intrusion Header .....17
2.6-L	SMBus Connector .....17
2.6-M	IPMB Connector .....17
2.6-N	Soft Power Connector .....18
2.6-O	Hardware Reset Switch Connector Installation .....18
2.6-P	Flash Utility .....18
2.7	Mounting the Motherboard in the Chassis .....19
2.8	Installing Memory .....20
2.9	Installing the CPU and Cooling Fan(s) .....23
2.10	Connecting IDE and Floppy Drives .....25
2.11	Installing Add-on Cards .....27
2.12	Connecting PS/2, USB, and Serial Devices .....29
2.13	Connecting the Power Supply .....30
2.14	You are done! .....31
2.15	Frequently Asked Questions (FAQ) .....32
<b>Chapter 3: BIOS Setup</b>	<b>33</b>
Introduction to the BIOS Setup	.....33
Starting Setup	.....33
Setup Keys	.....34
Getting Help	.....34
In Case of Problems	.....34
Setup Variations	.....34

3.1	Main Setup .....	35
3.1-A	Master and Slave Screens .....	36
3.2	Advanced Setup .....	38
3.2-A	Chipset Configuration Screen .....	40
3.2-B	Keyboard Configuration Screen .....	41
3.2-C	I/O Configuration Screen .....	41
3.2-D	PCI Configuration Screen .....	42
3.2-E	PCI/PnP IRQ Exclusion screen .....	42
3.2-F	PCI/PnP UMB Exclusion screen .....	42
3.3	Security Setup .....	43
3.4	Power Setup .....	43
3.5	Boot Setup .....	45
3.6	Exit Menu .....	45

**Chapter 4: System Resources ..... 46**

4.1	Beep Codes .....	46
4.2	Flash Utility .....	46

**Appendix I: SCSI Installation and LAN Information ..... 47**

Introduction .....	47
Support for Older SCSI Devices .....	47
Setting up SCSI Devices .....	47
Check the SCSI IDs .....	48
Terminate the ends .....	48
Connecting SCSI Devices .....	48
Connecting Internal Ultra160 and Ultra2 Devices .....	48
Connecting Wide SCSI Devices .....	50
More Information about Termination .....	51
Configuring the Adaptec 7899W SCSI with <i>SCSISelect</i> .....	52
Using <i>SCSISelect</i> .....	54
SCSI Bus Interface Definitions .....	54
Boot Device Options .....	54
SCSI Device Configuration Options .....	54
Advanced Configuration Options .....	55
LAN Information .....	56

**Appendix II: Glossary ..... 57**

Technical Support .....	63
Returning Merchandise for Service .....	63

## Before you begin...

### Check the box contents!

The retail motherboard package should contain the following:



Thunder K7 motherboard



34-pin floppy cable



UltraDMA-100/66/33 IDE cable



68-pin Ultra160 LVD SCSI cable



9-pin serial cable



I/O shield\*



Thunder K7 user's manual



Tyan driver CD



Adaptec SCSI Driver Disk

If any of these items are missing, please contact your **vendor/dealer** for replacements before continuing with the installation process.

\* If you require a different I/O shield solution, please contact your chassis vendor

# Chapter 1: Introduction

## 1.1 Congratulations!

You are now the owner of the world's first dual AMD®\* platform!

The Tyan Thunder K7™ is a high performance server platform designed for server and performance applications that require the power of dual AMD®\* processors. This platform utilizes the AMD 760MP™ chipset and can support CPU speeds through 1+GHz and front side bus speeds of 200 MHz or 266 MHz. Please see Tyan's website for updates and information concerning CPU information and support:

**<http://www.tyan.com>**

This integrated performance board is supported in an Extended ATX form factor. Some of the features included are onboard UltraDMA-100/66/33, onboard Adaptec® dual channel Ultra160 SCSI, dual 3Com® 3C920 10/100 LAN controllers, and onboard ATI® Rage XL™ 4MB graphics.

With both I/O and drive controller support onboard, the one 2x/4x mode AGP slot and five 64/32-bit 33MHz PCI slots are free for numerous types of add-on expansion cards. The four 25-degree angled 184-pin DDR DIMM sockets can support up to 3.5GB of PC1600/2100 registered DDR SDRAM.

Remember to visit Tyan's website at **<http://www.tyan.com>**. There you can find information on all of Tyan's products with FAQs, distributors list, and BIOS settings explanations.

**NOTE: Due to the extremely powerful dual processing capabilities of this motherboard, the Thunder K7 requires an APPROVED power supply. See PAGE 30 for recommendations and details of the APPROVED power supplies and power supply installation.**

\* At time of printing, CPU name was not confirmed. Check **<http://www.tyan.com>** for updates

# 1.2 Thunder K7 System Block Diagram

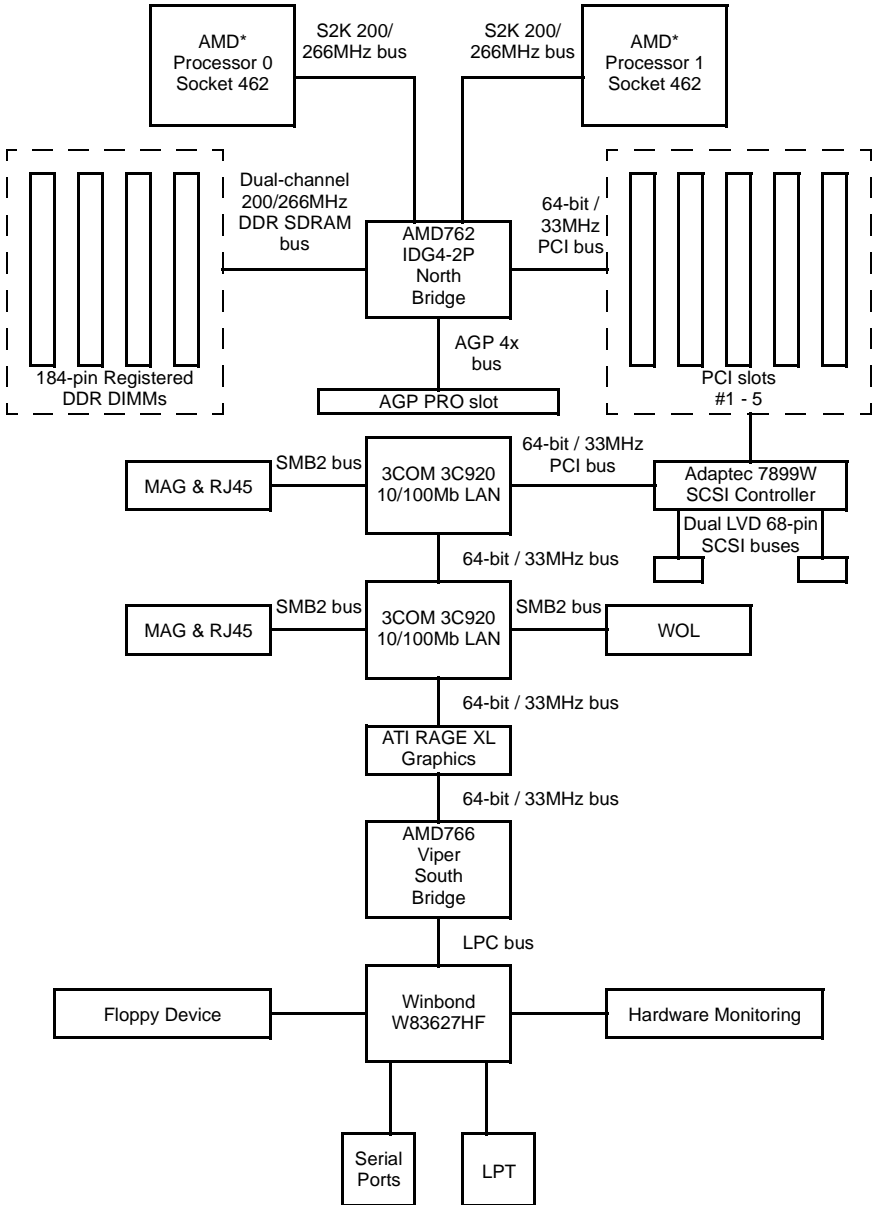

\* At time of printing, CPU name was not confirmed. Check <http://www.tyan.com> for updates

## 1.3 Hardware Specifications

<b>Processor Information</b>	Dual PGA462 ZIF sockets Supports dual AMD* processors Two onboard VRMs 200MHz and 266MHz system bus support
<b>Expansion Slots</b>	One AGP Pro slot supports 2x/4x modes Five 64/32-bit 33MHz 5V PCI slots Total of six usable slots
<b>Chipset Information</b>	AMD 760MP chipset IDG4-2 northbridge and Viper southbridge Winbond W83627HF Super I/O ASIC
<b>Hardware Monitoring (manufacturing option)</b>	Winbond W83627D hardware monitoring 3-pin fan monitoring headers 2-pin chassis intrusion header CPU temperature and voltage monitoring
<b>Server Management (manufacturing option)</b>	Supports IPMI Q-Logic Zircon controller (BMC) Support for IPMI, SDR, SEC, FRU I <sup>2</sup> C and 16550-based serial interfaces
<b>Memory</b>	Four 3.3V 184-pin DDR DIMM sockets 25-degree angled sockets for rackmount installation Supports up to 3.5GB** PC1600/2100 registered DDR Supports ECC (72-bit) memory modules
<b>Integrated I/O</b>	One floppy connector supports up to two drives Two 9-pin 16550-based serial ports (one via cable) One 25-pin SPP/ECP/EPP parallel port Four USB ports (two via optional cable) PS/2 keyboard and mouse ports
<b>Integrated PCI IDE</b>	Dual-channel master mode Up to four Enhanced IDE devices Support for UltraDMA-100/66/33 IDE and ATAPI compliant devices
<b>Integrated LAN</b>	Two 3Com 3C920 LAN controllers 10/100 Mbps data transfer rate per controller
<b>Integrated SCSI (manufacturing option)</b>	Adaptec AIC-7899W controller Dual-channel Ultra160 SCSI support 160Mbps maximum data throughput Supports up to 15 LVD SCSI devices per channel Channels A & B: 68-pin connector each
<b>Integrated 2D/3D graphics</b>	ATI Rage XL PCI Accelerator 4 MB 1Mx16 SDRAM frame buffer Standard 15-pin analog VGA port

\* At time of printing, CPU name was not confirmed. Check <http://www.tyan.com> for updates

\*\* Not validated at time of print, please check Tyan website for memory compatibility information:  
<http://www.tyan.com>

**BIOS**

Phoenix BIOS 4 Mb Flash  
Supports APM 1.2 & ACPI 1.0  
Auto-configuration of IDE hard disk types  
User settings of hardware monitoring\*  
Multiple boot options  
DMI 2.0 compliant

**Form Factor**

Ext. ATX footprint 12" x 13" (304.80mm x 330.20mm)  
One 24-pin and one 8-pin power connector  
Stacked mouse & keyboard ports  
Stacked two USB ports  
Stacked one parallel, one serial, and one VGA port  
Two RJ-45 LAN ports with LEDs

**Regulatory**

FCC Class B (Declaration of Conformity)  
European Community CE (Declaration of Conformity)

## 1.4 Software Specifications

**OS**

Windows NT/2000

\* Indicates an optional feature available on some Thunder K7 models



# Chapter 2: Board Installation

## 2.1 Installation

Once you've checked that everything is inside the box (see p. 4 for details), you will then be ready to install your motherboard. The mounting hole pattern of the motherboard matches the ATX board specifications, so your chassis must be capable of supporting an Extended ATX board (check the motherboard dimensions provided on p. 8).

## 2.2 How to install our products right.. the first time.

### Question: what's the first thing I should do?

The first thing you should do is read the **user's manual**. It contains important information which will make configuration and setup much easier, as well as provide information on device installation and component setup. By reading through the manual completely before installing your motherboard, you will have a complete overview on the installation.

## 2.3 Here are some safety tips:

- (1) **Ground yourself properly before removing your motherboard from the antistatic bag.** Unplug the power from your computer power supply and touch any metal part on the computer case. (You might also want to wear a grounded wrist strap.)
- (2) **Hold the motherboard by its edges and do not touch the bottom of the board.**
- (3) **Avoid touching motherboard components, IC chips, connectors, and leads.**
- (4) **Avoid touching pins of memory modules and chips.**
- (5) **Place motherboard on a grounded antistatic surface or on the antistatic bag.**

Having reviewed the precautions above, the next step is to take the motherboard out of the cardboard box and static bag, hold it by its edges, and place it on a grounded antistatic surface (such as the bag it came in), component side up. Then, inspect the board for damage.

**NOTE:****DO NOT APPLY POWER TO THE BOARD IF IT HAS BEEN DAMAGED!**

Press down on any of the socketed ICs if it appears that they are not properly seated (the board should still be on an antistatic mat or on top of the bag it came in). Do not touch the bottom of the board. Remember, don't take any electronic device out of its protective bag until you are ready to actually start installing it into the computer case (e.g. setting jumpers, etc.) If you do not ground yourself, you risk zapping the motherboard or adapter card. Subsequent problems may not arise immediately because electrostatic discharge, unlike physical damage, causes the device to fail over time.

## 2.4 Quick References for Jumpers

In this manual, the term “closed” and “on” are used when referring to jumpers (or jumper pins) that are active; “open” and “off” are used when referring to jumpers (or jumper pins) that are inactive. See **Figure 2.0a** and **Figure 2.0c** for examples of “on” and “off” pins and jumpers.

Jumpers and pins are connected by slipping the plastic jumper connector over the top of two adjacent jumper pins (indicated by 1-2 or 2-3). The metal rod inside the plastic shell bridges the gap between the two pins, completing the circuit. See **Figure 2.0b** and **Figure 2.0d** for more examples of 3-pin jumper connections. NOTE: The small number “1” indicates pin 1.

The tables and maps on the following pages will help you set the jumpers for CPU speed, infrared, and external connector pin assignments, among others. The miniature motherboard maps will help you locate the jumpers on your board. Full page maps of the motherboard can be found on the next two pages.

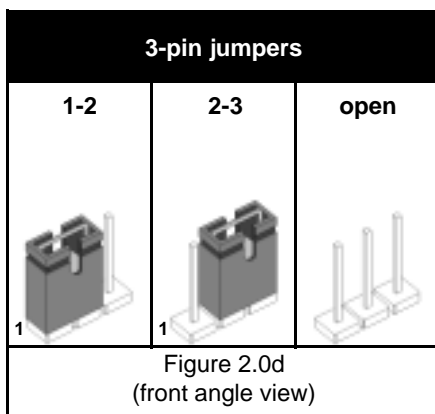
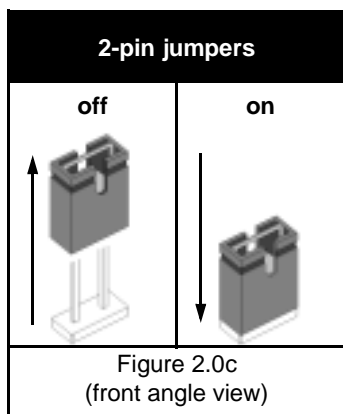
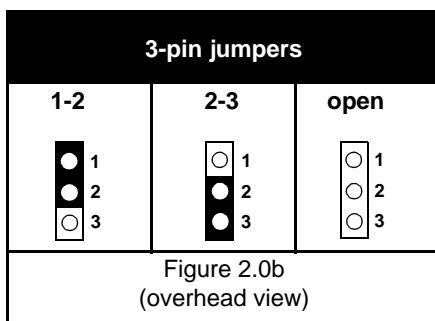
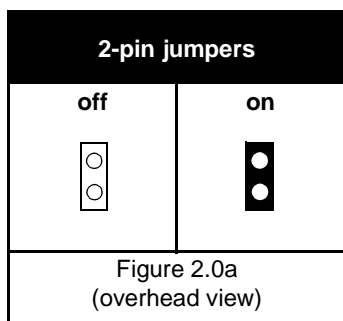



## 2.6 Setting up Jumpers and Onboard Connectors

Pinouts for certain connectors are available on the Tyan website: <http://www.tyan.com>

### 2.6-A. Front Panel Connector (J12)

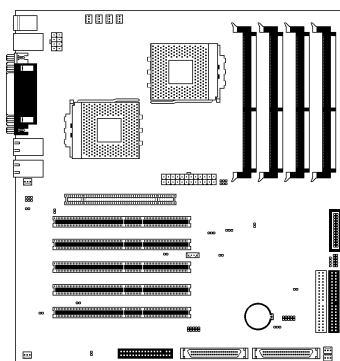

HDD LED			
VCC	1	2	LED

		3	4		
		5	6		
Rst Sw	ground	7	8	+5VCC	Speaker
	switch	9	10	no connect	
		11	12	no connect	
Pwr Sw	ground	13	14	spk	
	switch	15	16		
		17	18	VCC	Power LED
Slp Sw	ground	19	20	no connect	
	switch	21	22	ground	
		23	24	keylock	Key Lock
		25	26	ground	

Your chassis will usually come with connectors to install onto the motherboard, such as HDD and Power LEDs. The Front Panel Connector has been implemented for such purposes.

Abbreviations		
Rst	→	Reset
Pwr	→	Power
Slp	→	Sleep

### 2.6-B. CMOS Reset (J21)

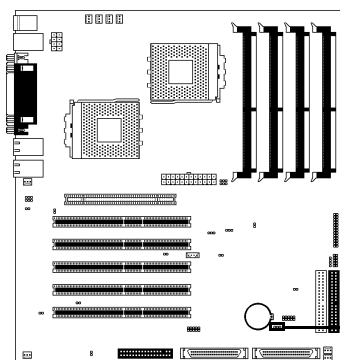

J21	1-2	2-3
	normal	clear

\* default is 1-2

If you have been locked out of your system because you forgot your password or set the CMOS incorrectly, or have just finished flashing your BIOS follow the instructions below.

1. Power off the system, and disconnect the power supply
2. Close pins 2-3 on J21
3. Wait about three seconds
4. Close pins 1-2 on J21, then power on the system again

By following this procedure, you will erase your password and reset the CMOS.

### 2.6-C. CPU Front Side Bus Jumpers (J48, J49; J52, J53)

With these jumpers, the CPU FSB can be set to either 200 or 266MHz.

**NOTE:**

Only non-retail/engineering sample CPUs are affected by these jumpers. Retail CPUs have their FSB locked in. **If your CPU can only run at 100MHz, altering these FSB jumpers will not make the CPU run at 133MHz.**

Tyan takes no responsibility and will not be held liable for damage related to operation of the CPU using different settings from those of the CPU manufacturer's specified default settings.

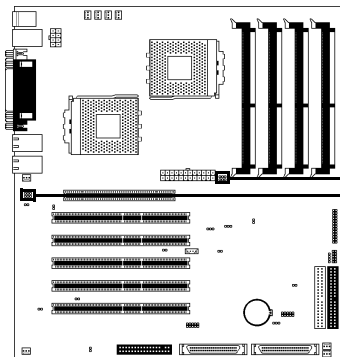

CPU2	266MHz	200MHz
<b>J52</b>	2-3	1-2
<b>J53</b>	1-2	1-2

**NOTE:** When using dual Athlon processors, you must use the **SAME FSB SETTING** for both CPUs!

CPU1	266MHz	200MHz
<b>J48</b>	1-2	2-3
<b>J49</b>	1-2	2-3

### 2.6-D. Onboard LAN Enable/Disable (J86, J88)

These jumpers can disable the onboard LAN ports.

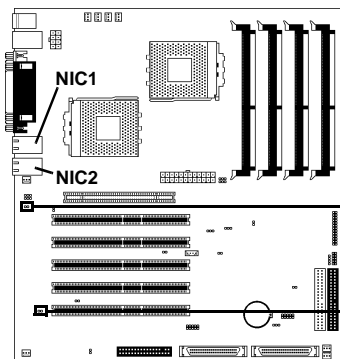

NIC2		
<b>J88</b>	close	open
	disable	enable

\* default is OPEN

NIC1		
<b>J86</b>	close	open
	disable	enable

\* default is OPEN

### 2.6-E. Onboard SCSI Enable/Disable (J80)

This jumper can disable the onboard SCSI ports. Please note that both SCSI ports will be disabled at the same time.

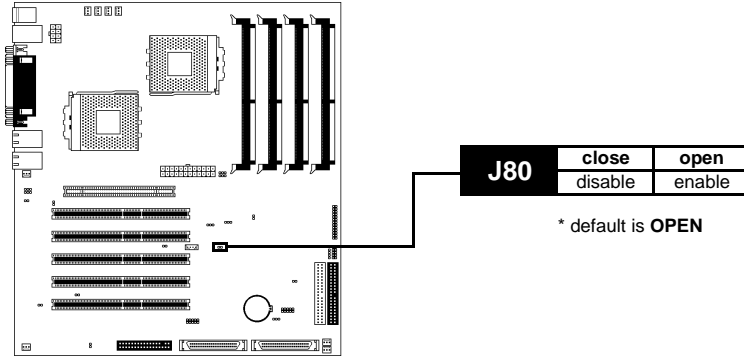

### 2.6-F. Onboard Video Enable/Disable (J85)

This jumper can disable the onboard video. Please note that the onboard AGP Pro slot will not be affected by this jumper.

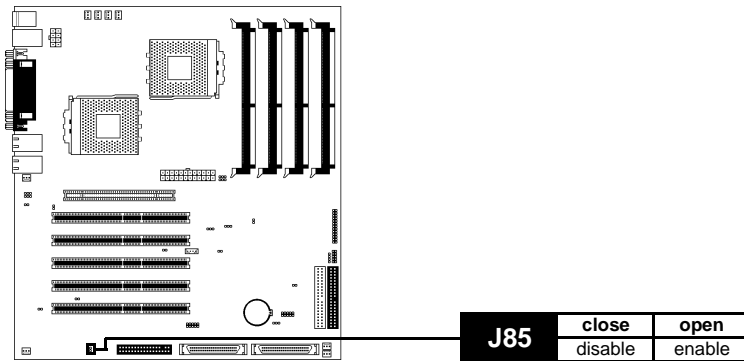

### 2.6-G. Serial Port 2 (J51)

This header allows for connection of a 9-pin serial port. This serial port header operates on a separate channel from the rear onboard serial port.

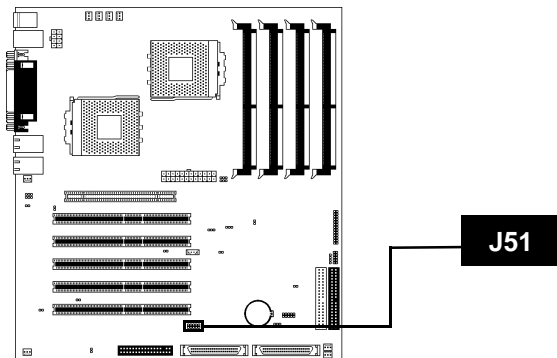

#### NOTE:

Tyan takes no responsibility and will not be held liable for damage incurred due to use of this header in combination with serial cables other than the serial cable that is included in the retail package for the Thunder K7.

### 2.6-H. LAN LED Header (J33)

This header is provided should you decide to implement front panel LAN activity status LEDs for one or both of the LAN ports.

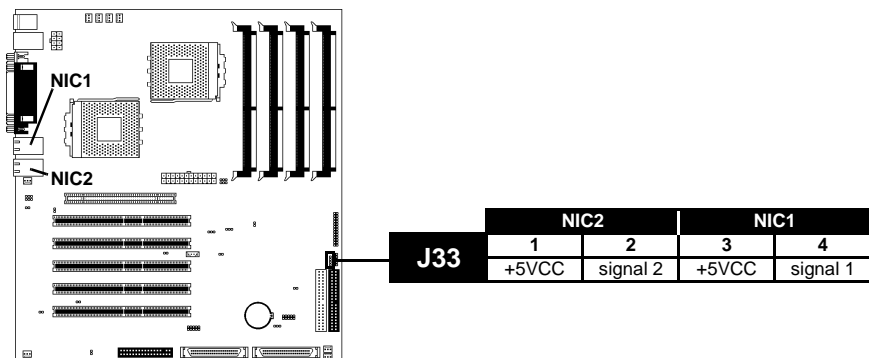

## 2.6-I. USB Header\* (J36)

This header allows for a USB connection\*. The USB channel on this header is on a separate channel from the rear USB connections channel.

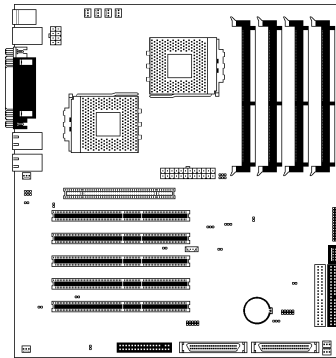

USB Header (J36)			
+VCC	1	2	ground
signal out	3	4	ground
signal in	5	6	signal in
ground	7	8	signal out
ground	9	10	+VCC

## 2.6-J. FAN Headers (P1FAN, P0FAN, FAN1, FAN2, FAN3, J54, J56, J58)

These headers allow for extra fans to be installed. P1FAN and P0FAN are reserved for Processor 1 and Processor 0 (respectively). All other fans are left to the user's discretion.

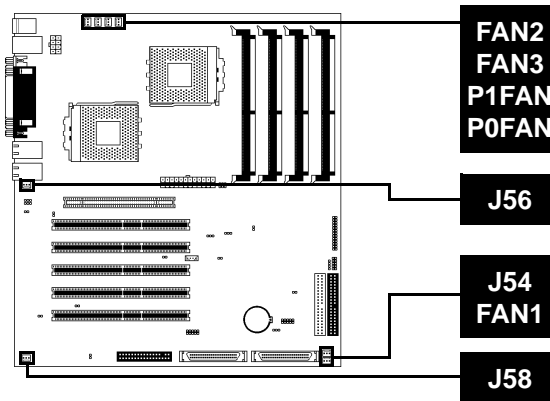

FAN			Specifications	
1	2	3	Voltage	12V
ground	+12V	speed	Amperage	1.2A

### NOTE:

The FAN connector has a **12V, 1.2A limitation**. Tyan takes no responsibility and will not be held liable for damage related to the misuse of any FAN jumper.

\* Only certain chassis allow for frontside USB connection. Please check with your chassis vendor for details on frontside USB connections.



### 2.6-K. Chassis Intrusion\* Header (J15) (optional)

This header is provided in the event that your chassis has a chassis intrusion feature\*. If this feature is enabled, the system administrator will be notified if the chassis is opened.

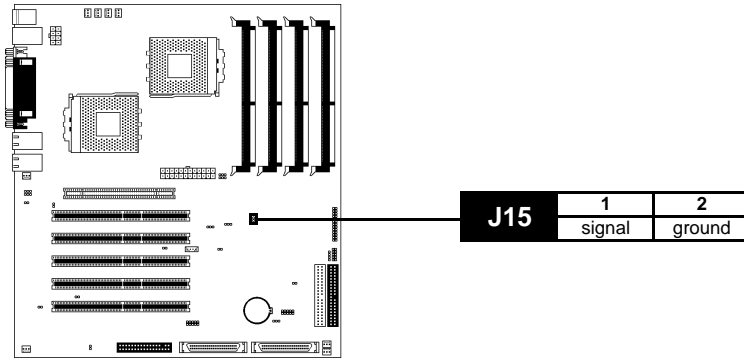

### 2.6-L. SMBus Connector (J59)

This is a reserved feature for debugging purposes only. DO NOT ADJUST OR TAMPER WITH THIS!

### 2.6-M. IPMB Connector (JP4) (optional)

This reserved **optional** header is provided for server management purposes.

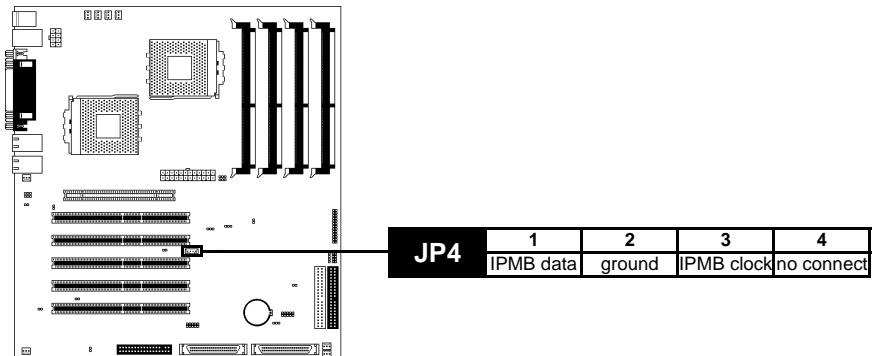

\* Only certain chassis allow for this feature. Please check with your chassis vendor for details about enabling this feature.

### **2.6-N. Soft Power Connector**

The soft power connector is part of jumper block **J12** (pins 13 and 15). This board uses the chipset for power management, including turning on and off the system. If the power button function option in the BIOS Power Management menu is set to "On/Off" (which is the default), pressing the power button once after the BIOS has booted up will turn the system on and off. If the power button function is set to Suspend, pressing the power button once will wake up the system or send it to Suspend mode. In this case, you cannot turn the system off unless you shut down through the Windows operating system or you hold the power button down for four seconds (BIOS-dependent feature).

### **2.6-O. Hardware Reset Switch Connector Installation**

The reset switch on your chassis case provides you with the Hardware Reset function, which is the same as power on/off, except that the system will immediately execute a cold start after the reset button is pushed. The reset switch needs to be connected to jumper block **J12** (pins 7 and 9).

### **2.6-P. Flash Utility**

You can upgrade the BIOS of this motherboard by using the Flash Utility (see **p. 46**). Check the Tyan website for more details: <http://www.tyan.com>







## 2.7 Mounting the Motherboard into the Chassis

Your chassis may include mounting hardware. If mounting hardware was included, you can use the following examples to help you in installing your motherboard into the chassis.

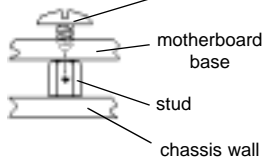
The chassis may have come with the studs integrated into the chassis wall, so in those cases you would only need to use screws (possibly included with your chassis) to install the motherboard. See the examples (**Figure 2.0**, shown below) for more details.

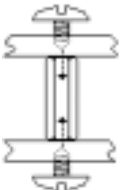
If the chassis includes mounting hardware without the studs pre-installed, then you will need to install the motherboard using the mounting hardware as shown in the examples **below**. Remember not to over-tighten any of the screws, or you might risk breaking internal traces in the surrounding area, or damage the motherboard in some other way.

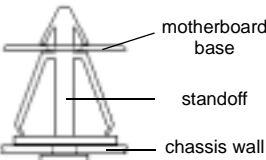
Other examples of how to install your motherboard using other hardware (that may or may not have been included with your chassis) are shown below.

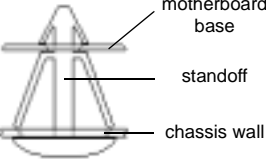
Type of hardware	One solution for installing motherboard	Another solution	Another solution
	 <p>screw</p> <p>motherboard base</p> <p>stud</p> <p>chassis wall</p>		
	 <p>motherboard base</p> <p>standoff</p> <p>chassis wall</p>		
	 <p>motherboard base</p> <p>standoff</p> <p>chassis wall</p>		

**Figure 2.0**





**NOTE:**

The diagrams above are only representative of a few solutions for installing a motherboard into the chassis. The installation procedure for installing your motherboard into the chassis may differ.

## 2.8 Installing Memory

Please keep in mind that although some memory modules may appear to be high-quality, they may contain inferior or substandard parts. The type of memory you choose to install should be checked against the memory compatibility list, which is available from Tyan's website at <http://www.tyan.com>

Here are some details of memory installation for this board:

-  At least one REGISTERED DDR DIMM\*\* must be installed for the system to POST.
-  Supports 128MB, 256MB, 512MB\*, & 1024MB\* PC1600/2100 REGISTERED DDR ONLY\*\*.
-  All installed memory will be automatically detected, so there is no need to set any jumpers.
-  The motherboard supports up to 4GB\* of PC1600/2100 REGISTERED DDR memory ONLY\*\*.

### Memory Installation Procedure\*\*\*

- Step 1** Line your module up so that the pins fit into the socket. There is only one way your DIMM can fit properly. Make sure that the short row of pins is lined up with the short gap in the DIMM socket, just as the long row of pins should line up with the long gap in the DIMM socket.

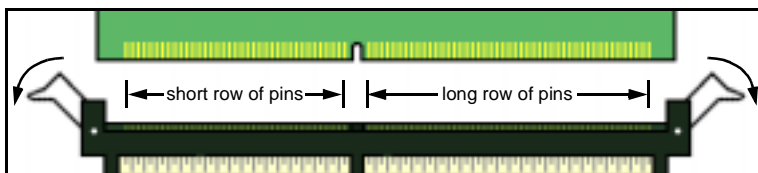

- Step 2** Insert the DIMM by pushing the module into the socket **with even force**. Do not insert one end and then the other: install the whole module at once or you might bend the DIMM pins. Make sure the DIMM is securely seated.

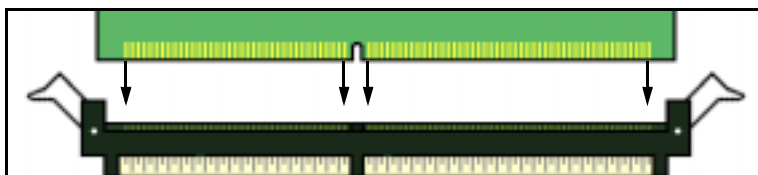

\* Not validated at time of print, please check Tyan website for memory compatibility information:  
<http://www.tyan.com>

\*\* This board supports DDR memory ONLY. Please check that you are using the correct type of memory.

\*\*\* Manufacturer suggestion: start installation with DIMM (bank) 1 (see p.22)

**Step 3** Lock the DIMM into place by pushing the clips back on either end of the socket onto the notches in the ends of the DIMM (see pictures below for details).

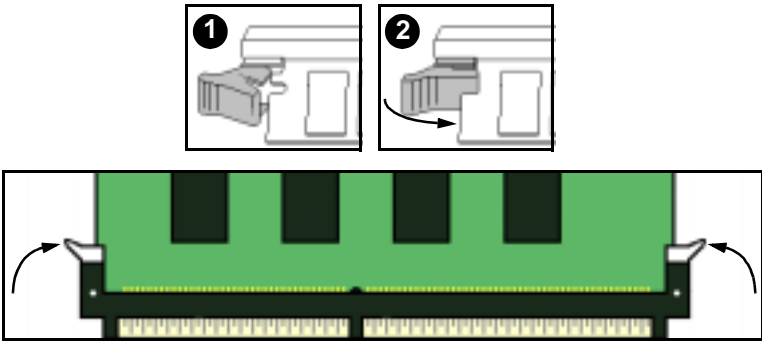

### Removing a DIMM

Removing a DIMM is just the reverse: pull back the clips from the DIMM (see pictures below), and carefully pull the module straight out. Place the DIMMs in an anti-static bag as soon as you remove them to avoid static damage.

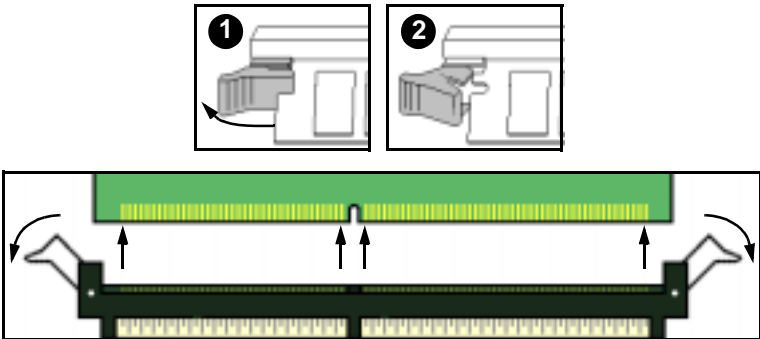

### Suggested Memory Configurations

The table below shows some of the possible memory configurations. **Not all possible configurations are listed.** Your memory configuration may differ from one or more of the combinations\*\* shown below.

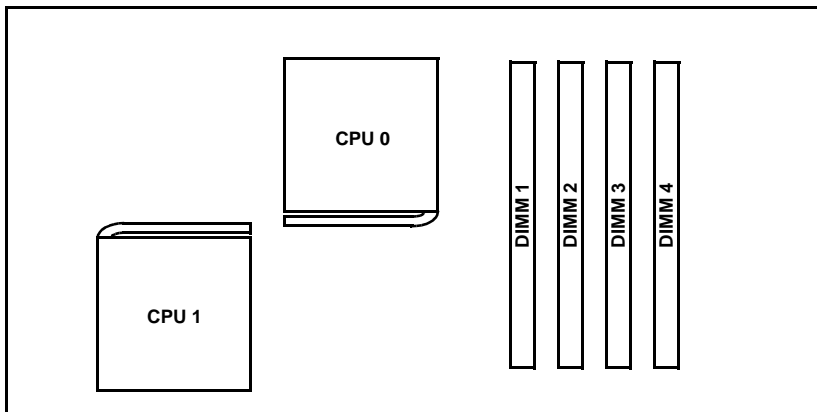

**Total possible memory is 4GB\* PC1600/2100 registered DDR SDRAM**

DIMM 1**	128MB	128MB	128MB	256MB	256MB	512MB	1024MB	1024MB
DIMM 2	0	0	128MB	0	256MB	512MB	1024MB	1024MB
DIMM 3	0	0	0	256MB	256MB	0	512MB	1024MB
DIMM 4	0	64MB	0	0	256MB	1024MB	512MB	512MB
TOTAL	128MB	192MB	256MB	512MB	1024MB	2048MB*	3072MB*	3584MB*





\* Not validated at time of print, please check Tyan website for memory compatibility information:  
<http://www.tyan.com>

\*\* Manufacturer suggestion: start installation with DIMM (bank) 1 (see p.22)

## 2.9 Installing the CPU and Cooling Fan

Certain AMD\* processors up to 1+GHz can be used on this board. For more information on CPU compatibility, check Tyan's website at: <http://www.tyan.com>.

When installing your CPU, remember the following:

-  The CPU is a sensitive electronic component and can easily be damaged by static electricity
-  Do not touch the CPU pins with your fingers
-  You should be able to insert the CPU into the socket with virtually no force
-  Do not press down hard on the CPU as you might bend or break pins, or otherwise damage the CPU
-  The CPU voltage will automatically be detected by the motherboard, so there is no need to set any jumpers or BIOS setting.

### Installing the AMD\* CPU

Before installing the CPU, check it for any visible damage. Make sure none of the pins are bent or missing. Be sure where Pin 1 is on both the CPU and the socket. The following steps each have a corresponding picture next to it to help guide you through the installation.

**Step 1** Carefully lift the arm of the ZIF socket until it is at a 90 degree angle pointing away from the motherboard. Be very careful not to damage any components that might be next to the socket.

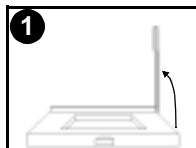

**Step 2** There are two beveled corners on the CPU, which will match the two angled corners on the socket. Carefully install the CPU by lining both Pin 1 on the CPU and Pin 1 on the socket, making sure the pins actually fit into the socket. **Do not** force the CPU into the socket: check the pin alignment of CPU pins to socket holes.

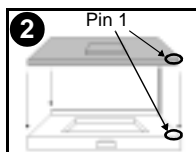

**Step 3** Push down lightly on the CPU while lowering the arm on the socket to secure the CPU (see right). A squeaking noise may be heard while lowering the arm, or the socket may make a 'click' noise when the arm is locked into position: these noises are normal.

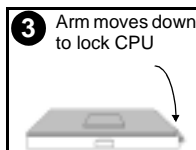

\* At time of printing, CPU name was not confirmed. Check <http://www.tyan.com> for updates

## Installing the Cooling Fan(s)

After a CPU has been installed, you will need to **install the proper cooling device\*** for the CPU. This device, a heatsink/fan combination, can be purchased at many computer retail stores. Installation of the cooling device\* may vary depending on the fan manufacturer's design. You should also take space into consideration when install a cooling device\*: make sure the cooling device is not too big, or else you may end up damaging components around the CPU socket.

Tyan **highly recommends** that you use some type of thermal compound (available from many computer retail stores), between the CPU and heat sink, to maximize distribution of heat away from the CPU. Please use extra caution when installing any type of clamp-style fan, or else damage may occur to the CPU socket, and/or the CPU itself. See **the picture to the right** for an example of how to connect the cooling fan's power supply. Another diagram has also been provided below, to aid in CPU fan installation onto the socket. Check with your cooling device\* vendor for more details about installation.

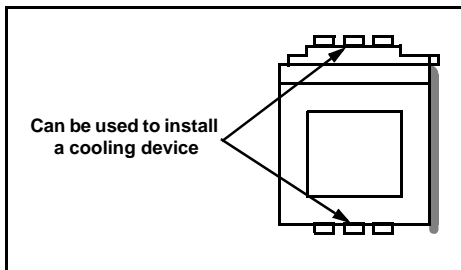
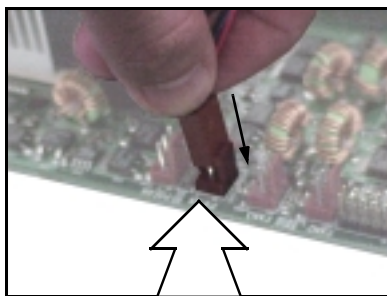

**Mounting points on the CPU socket**



**Close-up of fan connector**

FAN		
1	2	3
ground	+12V	speed

Specifications	
Voltage	12V
Amperage	1.2A

### NOTE:

The FAN connector has a **12V, 1.2A limitation**. Tyan takes no responsibility and will not be held liable for damage related to the misuse of any FAN jumper.

## Installing Chassis Fans

Alternatively, if you wish to also install chassis fans for increased cooling, headers are provided to power those fans as well (see p. 16, section 2.6-J). Chassis fan installation will vary depending on your chassis manufacturer's design. Please check with your chassis manufacturer for details on proper chassis fan installation.

\* Please check the AMD website for recommended cooling device solutions: <http://www.amd.com>



## 2.10 Connecting IDE and Floppy Drives

A variety of IDE and ATAPI-compliant devices can be installed on this motherboard, such as hard disk drives (HDDs) and CD-ROMs.

Please keep in mind that on this motherboard, the primary IDE connector is **BLACK**, and the secondary IDE connector is **WHITE**. See the picture to the right for an example of the IDE cable properly connected to the motherboard, with the **BLUE** end of the IDE cable installed on the motherboard.

Pin 1 on the IDE cable is usually denoted by a red or colored stripe down one side of the cable. That side of the cable must match Pin 1 on the motherboard's IDE connector. There will also be a key pin on the cable that matches with a notch in the IDE connector, to ensure proper installation. Consult the documentation that came with your IDE/ATAPI device, or contact the device's manufacturer for more details on installation.

Please note that UltraDMA-100/66 IDE HDDs require a special 80-wire cable which has additional grounding wires. This cable has been included with this motherboard for your convenience. The UltraDMA-100/66 cable is backwards compatible with UltraDMA-33 and legacy IDE HDDs.

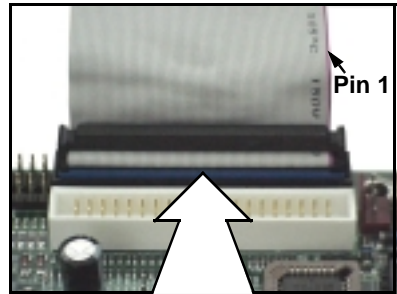

**BLUE end goes to IDE connector**

### NOTE:

Only Tyan-approved cables are recommended for this motherboard. If you are using an existing configuration with older cables, your system might not function properly. Use only Tyan-approved cables (i.e. the ones included with your motherboard).

### Some symptoms of incorrectly installed HDDs are...

<b>HDDs are not auto-detected</b>	May be a Master/Slave configuration problem, bad IDE cable, or BIOS mis-configuration. Consult the HDD documentation or contact your HDD vendor.
<b>Hard Disk Drive Fail message at bootup</b>	May be a bad cable or lack of power going to the drive. Check the cables for damage and bad connections.
<b>No video or beeps during bootup</b>	Usually means the cable was installed backwards.
<b>HDD lights are constantly on</b>	Bad IDE cable or defective drives/motherboard. Try another HDD, or contact your HDD vendor.
<b>HDD does not power on</b>	Check power cables and cabling. May be a bad power supply or IDE drive problem.

## Connecting Floppy Drives

See **the picture below** for an example of a floppy cable. Most of the current floppy drives on the market require that the cable be installed with the colored stripe positioned next to the power connector. In most cases, there will be a key pin on the cable which will force a proper connection of the cable.

The first floppy drive (sometimes denoted as A:) is usually attached to the end of the cable with the twist in it. Drive B: is usually connected to the second or third connector in the cable (the second or third connector after you install Drive A:). Refer to your floppy drive's installation instructions (if available), or contact your dealer if you are unsure about how to attach the floppy drive(s). Remember, you can only have 2 floppy drives connected at any given time.

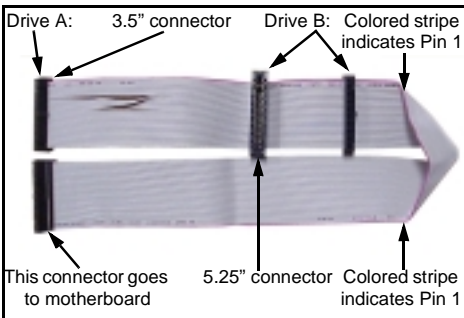
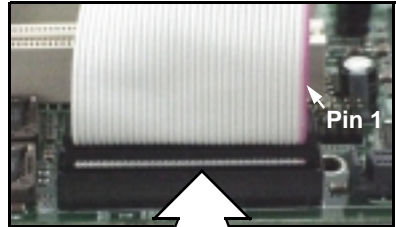
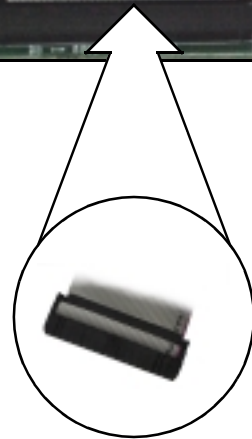

Figure 2.4\*



**Match striped side with Pin 1**

### Some symptoms of incorrectly installed FDDs are...

<p><b>FDDs are not auto-detected</b></p>	<p>Usually caused by faulty cables, cables put in backwards, or a bad floppy or motherboard. Try another floppy drive to verify the problem or try another cable. Also check to see if the onboard floppy is enabled in the BIOS.</p>
<p><b>Floppy Drive Fail message at bootup</b></p>	<p>The cable, floppy, or motherboard may be faulty. Try another cable or floppy drive to verify.</p>
<p><b>FDD does not power on</b></p>	<p>Check power cables and cabling. May be a bad power supply or IDE drive problem.</p>
<p><b>FDD light is constantly on</b></p>	<p>Usually signifies that the cable is on backwards. Reverse the cable at the floppy drive end and try again.</p>

\* Cable may vary. Diagram provided for reference only.

## 2.11 Installing Add-on Cards

There are a few rules you need to follow when installing add-on cards. In order to assure proper operation and a quick installation, adhere to the following guidelines:

- ➡ If you are going to install a PCI-bus interface card on your system, be aware that any one of the five PCI slots can support a Master or Slave device.
- ➡ NEVER force a card into a slot. If it doesn't fit, look at the socket on the motherboard to make sure there are no wires or other obstructions to the slot.
- ➡ NEVER plug an ISA card into a PCI slot. You will void your warranty and damage your system board if you do this.
- ➡ When plugging the card in, especially when installing long cards, try to push the entire card in at one time. Don't force one end of the card into the socket first and then the other, or a rocking motion between the card and the slot might occur, and could damage the pins within the socket.
- ➡ Make sure the cards are seated securely into their slots.
- ➡ Before turning on the system, make sure no cards are touching.
- ➡ Check the PCI device specifications with the PCI slot specifications (p.5) BEFORE installing!

When installing the add-on cards, make sure the cards are installed with **even** force; do not insert one end and then the other. See the before (**Figure 2.1a**) and after (**Figure 2.1b**) example installation images below for details.

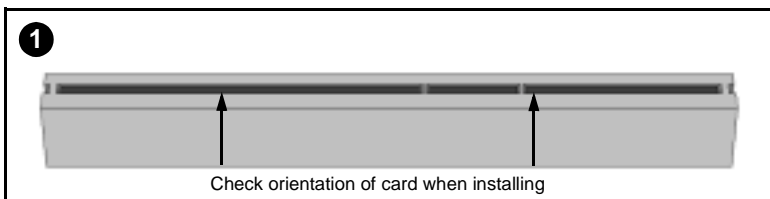

**Figure 2.1a\***

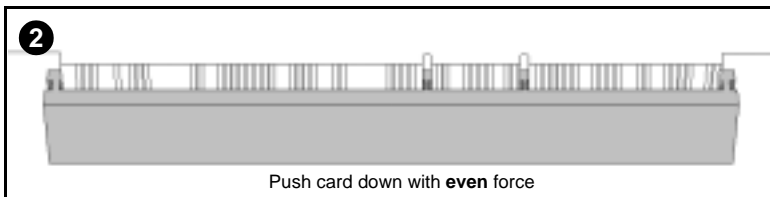

**Figure 2.1b\***

\* diagrams are provided as an example for installation, and may not represent an actual slot

### About the AGP Pro slot

If you are planning to install an AGP Pro-compliant card, a small plastic retention piece must be removed from the AGP Pro slot before the card can be installed.



Figure 2.2a



Figure 2.2b

First, make sure the card you're installing is an AGP Pro-compliant card. Next, locate the small plastic retention piece in the AGP Pro slot (**Figure 2.2a**, above), and use a tool with a small hard tip (such as a pen) to remove the retention piece (**Figure 2.2b**, above). **Tyan recommends you save this piece for future use (e.g. in case a regular AGP card is installed later on).**

To further ensure that the AGP card will not rock back and forth, make sure that the metal endpiece of the AGP card is flush with the motherboard edge.

#### NOTE:

Only remove the small plastic retention piece if you are going to install an AGP Pro-compliant card. Installing a regular AGP card without the retention piece can cause the card to rock back and forth, possibly damaging the card and/or motherboard.

Tyan takes no responsibility for and will not be held liable for damage related to use of regular AGP cards without the retention piece installed.

## 2.12 Connecting PS/2, USB, and Serial Devices

This motherboard includes ports for PS/2 mouse and keyboard, Universal Serial Bus (USB) devices, and serial and parallel devices. Please note that the upper PS/2 port is the mouse port, and the lower PS/2 port is for the keyboard (see **Figure 2.3** below).

Installation of peripheral/external devices may vary. For details on installation of devices into the various ports shown below, please consult your device's documentation, device manufacturer, or your dealer for details.

### Connecting Serial and Parallel Ports

The serial and parallel ports can be used to connect various devices such as a mouse or printer. The connectors can only be connected one way: be sure and check the orientation of the connector before installing it into the port.

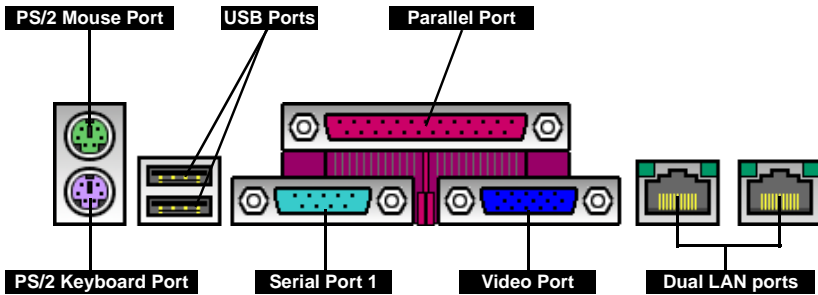

Figure 2.3

## 2.13 Connecting the power supply

This motherboard requires an **APPROVED, 400W or more, power supply**. Tyan recommends using one that conforms to supporting **dual AMD\* processors**, such as the **Delta DSP465AB-A** or the **NMB SD025A460WSW**.

### Step 1

Shown on the **right**, in **Figure 2.4a**, is the 8-pin connector of the dual AMD Athlon power supply.

You must connect this plug **FIRST**.

Note the clip in the image: it will help you install the plug correctly.

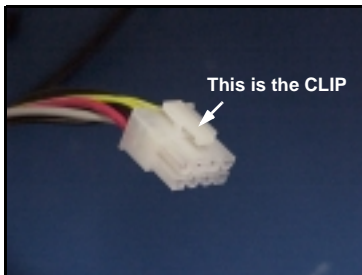

Figure 2.4a

### Step 2

Shown on the **right**, in **Figure 2.4b**, is the 8-pin connector plugged into the board.

The clip is over the **TAB** of the onboard connector.

When you connect the cable into the motherboard's 8-pin onboard connector, it will make a **CLICK** noise. This is normal.

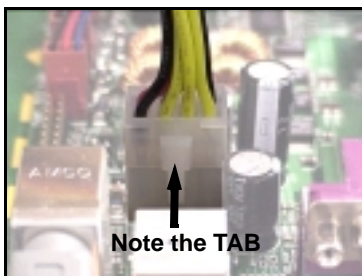

Figure 2.4b

### Step 3

Shown on the **right**, in **Figure 2.4c**, is the 24-pin connector of the dual AMD Athlon power supply.

You must connect this plug **SECOND**.

Note the clip in the image: it will help you install the plug correctly.

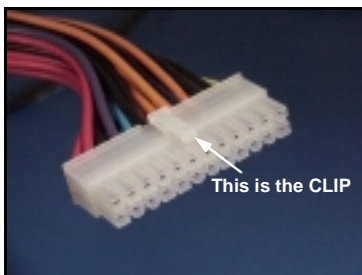

Figure 2.4c

### Step 4

Shown on the **right**, in **Figure 2.4d**, is the 24-pin connector plugged into the board.

The clip is over the **TAB** of the onboard connector.

When you connect the cable into the motherboard's 24-pin onboard connector, it will make a **CLICK** noise. This is normal.

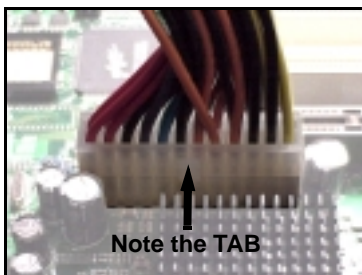

Figure 2.4d

\* At time of printing, CPU name was not confirmed. Check <http://www.tyan.com> for updates

## 2.14 You are done!

Other than checking the jumper settings and cable connections, and putting the case back together, you are done.

Installing a new motherboard may seem difficult, but by following these directions, you should have a fairly uneventful time installing our products. If you do encounter problems, your vendor/dealer will be able to help you, or you can consult one of our many technical support resources (see **p. 63**).

## 2.15 Frequently Asked Questions (FAQ)

**Q: My system sometimes becomes unstable. How should I check the system?**

A: The first thing to do is to check and see if you have any device conflicts related to the IRQ, or DMA. If you are using Microsoft Windows, the Control Panel is a good place to start investigating the conflict. Please consult your operating system documentation for details. Secondly, slowing down the memory timing in the BIOS' chipset setup section might help the situation as well. Many memory modules are not suitable for high performance systems and might be the main source of your problem. Also check to make sure you are using an **APPROVED power supply**, such as the **Delta DSP465AB-A** or the **NMB SD025A460WSW**. Lastly, make sure the motherboard is receiving adequate cooling.

**Q: I have a question about memory compatibility; what memory will work on my motherboard?**

A: Memory compatibility information can be found on Tyan's website at: <http://www.tyan.com>

**Q: Where can I get additional accessories for my Tyan motherboard?\***

A: You can purchase additional accessories such as USB cables\*, as well as other Tyan-approved accessories at the Tyan Computer Online Store: <http://www.etyan.com>

**Q: Where do I get pinout information for my motherboard?**

A: Pinouts of certain headers are available on the Tyan website: <http://www.tyan.com>

**Q: My motherboard is dead, how do I return it?**

A: Contact the place of purchase or your distributor for assistance to return the motherboard for service. RMA issues will not be handled via e-mail by Tyan Tech Support. Please refer to the URL link here for more details: [http://www.tyan.com/support/html/rma\\_faq.html](http://www.tyan.com/support/html/rma_faq.html)

**Q: How do I upgrade my BIOS?**

A: Check the section about the Flash Utility (see **p. 46**) for information on upgrading your BIOS. BIOS update files, flash utilities, and instructions on how to install them are also available from the Tyan website at: <http://www.tyan.com>

**Q: Why do I get a "CMOS checksum invalid" error message during POST?**

A: If you get the above error message or "Invalid configuration, run Setup" message, it is an indication that the CMOS battery needs to be changed. Contact your dealer for assistance. Once you've replaced your battery or flashed your BIOS, don't forget to check the Clear CMOS section (see **p.12**) so that you can reset your CMOS.

\* If your chassis supports frontside USB connectors, it will usually come with the necessary cables. Check that your chassis is frontside USB capable. Please check with your chassis vendor for details.



# Chapter 3: BIOS Setup

## Introduction to the BIOS setup

The BIOS is the basic input/output system, required by the computer to perform functions such as CPU and hard drive support. This chapter describes different settings for the BIOS that can be used to configure your system.

**The BIOS section of the manual is subject to change without notice and is provided here for reference purposes only. The settings and configurations of the BIOS are current at the time of print, and therefore they may not be exactly the same as that displayed on your screen.**

This manual describes the BIOS setup program. The setup program lets you modify basic configuration settings. The settings are then stored in a dedicated battery-backed memory, called NVRAM, that retains the information when the power is turned off.

The BIOS in your motherboard is a customized version of an industry-standard BIOS for IBM PC AT-compatible personal computers. It supports Intel x86 and compatible processors. The BIOS provides critical low-level support for the system central processing, memory, and I/O subsystems.

The BIOS has been customized by adding important, but non-standard, features such as virus and password protection, power management, and detailed fine-tuning of the chipset controlling the system. The rest of this manual is intended to guide you through the process of configuring your system using this BIOS setup program.

## Starting Setup

The BIOS is immediately activated when you first turn on the computer. The BIOS reads system configuration information in CMOS RAM and begins the process of checking out the system and configuring it through the Power-On Self Test (POST).

When these preliminaries are finished, the BIOS seeks an operating system on one of the data storage devices (HDD, floppy drive, etc.) If one is found, the BIOS will launch that operating system and hand control of system operations to it. You can start the setup program by pressing the **[F2]** key while the system is booting up.

## Setup Keys

The table below shows how to navigate in the setup program using the keyboard.

Key	Function
Tab	Moves from one selection to the next
Left/Right Arrow Keys	Change from one menu to the next
Up/Down Arrow Keys	Move between selections
Enter	Opens highlighted section
PgUp/PgDn Keys	Change setting

## Getting Help

Press **[F1]** to display a small help window that describes the appropriate keys to use and the possible selections for the highlighted item. To exit the Help Window press **[ESC]** or the **[F1]** key again.

## In Case of Problems

If you discover that you have trouble booting the computer after making and saving changes with the BIOS setup program, you can restart the computer by either:



Holding the power button down until the computer shuts off

The best advice is to alter only settings that you thoroughly understand. In particular, do not change settings in the Chipset screen unless you are absolutely sure that you need to. The Chipset defaults were carefully chosen by Tyan or your system manufacturer for the best performance and reliability. Even a seemingly small change to the Chipset setup may cause the system to become unstable.

## Setup Variations

Not all systems have the same setup program. While the basic look and function of the setup program remains more or less the same for all systems, the appearance of your Setup screen may differ from the screens shown here. Each system design and chipset combination require custom configurations. In addition, the final appearance of the setup program depends on your system designer. Your system designer can decide that certain items should not be available for user configuration, and remove them from the BIOS setup program.

### 3.1 Main Setup

In this screen, you can alter general features such as the date and time, as well as access the IDE configuration screens. Note that the options listed below are for options that can directly be changed within the **Main Setup** screen.

<b>System Time</b>	<b>FORMAT:</b>	<i>hh:mm:ss</i>
	<b>OPTIONS:</b>	hh = hours mm = minutes ss = seconds
	<b>NOTES:</b>	System time works on 24-hour format

<b>System Date</b>	<b>FORMAT:</b>	<i>mm/dd/yyyy</i>
	<b>OPTIONS:</b>	mm = month dd = day yyyy = year

<b>Legacy Diskette A (..B)</b>	<b>FORMAT:</b>	<i>[size in MB] [media dimensions]</i>
	<b>OPTIONS:</b>	360KB, 5 1/4" 1.2MB, 5 1/4" 720KB, 3 1/2" 1.44/1.25MB, 3 1/2" 2.88MB, 3 1/2" Not Installed Disabled
	<b>NOTES:</b>	This option is provided for your floppy device needs. It is also linked to the <b>Boot Sequence</b> in the <b>Boot Menu</b> .

<b>Primary Master/Slave</b>	Discussed on <b>p. 36</b>
-----------------------------	---------------------------

<b>Secondary Master/Slave</b>	Discussed on <b>p. 36</b>
-------------------------------	---------------------------

<b>System / Extended Memory</b>	<b>FORMAT:</b>	<i>[size in KB]</i>
	<b>OPTIONS:</b>	N/A
	<b>NOTES:</b>	Cannot be altered. Provided for your information only.

<b>Large Disk Access Mode</b>	<b>FORMAT:</b>	<i>[option]</i>
	<b>OPTIONS:</b>	Other    Select Other if you have another operating system such as UNIX.
	<b>NOTES:</b>	A large disk is one that has more than 1024 cylinders, more than 16 heads, or more than 63 tracks per sector.

<b>Boot Summary Screen</b>	<b>FORMAT:</b>	<i>[option]</i>
	<b>OPTIONS:</b>	Disabled Enabled
	<b>NOTES:</b>	Enables or disables the information screen seen on boot-up of the system.

### 3.1-A. Master and Slave screens

The following options are for setting the configuration of the IDE devices installed in the system.

Type	<b>FORMAT:</b>	[option]
	<b>OPTIONS:</b>	None Auto-typing is not able to supply the drive type, or the user has selected <i>None</i> to disable any drives that might be installed.
		1 to 39 Pre-configured drive parameters. This option is dependent on your drive.
		User The user must define the different parameters of the drive.
		Auto Auto-detect the drive parameters.
		IDE Removeable Removeable read-and-write media (e.g. Zip drive).
		CD-ROM Readable CD-ROM drive.
		ATAPI Removeable Removeable ATAPI media (e.g. USB Zip drive).
	<b>NOTES:</b>	All options are dependent on the drive.
Cylinders	<b>FORMAT:</b>	[#]
	<b>OPTIONS:</b>	1 to 65,536 Number of cylinders.
	<b>NOTES:</b>	All options are dependent on the drive.
Heads	<b>FORMAT:</b>	[#]
	<b>OPTIONS:</b>	1 to 16 Number of read/write heads.
	<b>NOTES:</b>	All options are dependent on the drive.
Sectors/Track	<b>FORMAT:</b>	[#]
	<b>OPTIONS:</b>	1 to 63 Number of sectors per track.
	<b>NOTES:</b>	All options are dependent on the drive.
Landing Zone	<b>FORMAT:</b>	[#]
	<b>OPTIONS:</b>	1 to 2048 Number of the cylinders specified as the landing zone for the read/write heads.
	<b>NOTES:</b>	IDE devices do not require a Landing Zone.
Write Precomp	<b>FORMAT:</b>	[#] or [None]
	<b>OPTIONS:</b>	1 to 2048 None Number of the cylinder at which to change the write timing.
	<b>NOTES:</b>	IDE devices do not require a Write Precomp.

(master and slave screens, continued)

<b>Multi-Sector Transfers</b>	<b>FORMAT:</b>	[option]	
	<b>OPTIONS:</b>	Disabled	Disables the feature.
		Standard	Standard is 1 sector per block.
		2 sectors 4 sectors 8 sectors 16 sectors	Number of sectors transferred per block.
<b>NOTES:</b>	All options are dependent on the drive.		

<b>LBA Mode Control</b>	<b>FORMAT:</b>	[option]	
	<b>OPTIONS:</b>	Disabled / Enabled	Enabling LBA causes logical block addressing to be used in place of Cylinders, Heads, and Sectors.
	<b>NOTES:</b>	All options are dependent on the drive.	

<b>32-bit I/O</b>	<b>FORMAT:</b>	[option]	
	<b>OPTIONS:</b>	Disabled / Enabled	Enables 32-bit communication between CPU and IDE card. Requires PCI or local bus.
	<b>NOTES:</b>	All options are dependent on the drive.	

<b>Transfer Mode</b>	<b>FORMAT:</b>	[option]	
	<b>OPTIONS:</b>	Standard Fast PIO 1 Fast PIO 2 Fast PIO 3 Fast PIO 4	Selects the method for transferring data between the HDD and system memory.
	<b>NOTES:</b>	The Setup menu only lists those options supported by the drive and platform.	

<b>SMART Monitoring</b>	<b>FORMAT:</b>	[option]	
	<b>OPTIONS:</b>	Disabled / Enabled	Self-Monitoring Analysis-Reporting Technology, which monitors condition of the HDD and reports when a catastrophic IDE failure is about to happen.

### 3.2 Advanced Setup

Options such as I/O device interfaces can be altered through this screen.

<b>Reset Configuration Data</b>	<b>FORMAT:</b>	[option]
	<b>OPTIONS:</b>	Yes Erases all configuration data in a section of memory for ESCD (Extended System Configuration Data) which stores the configuration settings for non-PnP plug-in devices.
		No Does not erase ESCD.
<b>NOTES:</b>	Select Yes when required to restore the manufacturer's defaults.	

<b>USB Host Controller</b>	<b>FORMAT:</b>	[option]
	<b>OPTIONS:</b>	Disabled / Enabled Enables or disables the USB onboard controller.

<b>USB BIOS Legacy Support</b>	<b>FORMAT:</b>	[option]
	<b>OPTIONS:</b>	Disabled Enables or disables support for Legacy USB.

<b>Chipset Configuration</b>	Discussed on p. 40
------------------------------	--------------------

<b>Keyboard Configuration</b>	Discussed on p. 41
-------------------------------	--------------------

<b>I/O Device Configuration</b>	Discussed on p. 41
---------------------------------	--------------------

<b>Onboard PCI IDE</b>	<b>FORMAT:</b>	[option]
	<b>OPTIONS:</b>	Both 'Both' enables both IDE ports.
		Disabled Disables the ports.
		Primary Enables the primary port only.
		Secondary Enables the secondary port only.

<b>Serial Port A (..B)</b>	<b>FORMAT:</b>	[option]
	<b>OPTIONS:</b>	Disabled 'Disabled' turns off the port.
		Enabled 'Enabled' requires you to enter the base I/O address and the INT number on the next line.
		Auto 'Auto' makes the BIOS configure the port during POST.

(advanced setup, continued)

<b>Mode</b>	<b>FORMAT:</b>	[option]
	<b>OPTIONS:</b>	IR Normal Selects the mode to use. IR = Infrared
	<b>NOTES:</b>	This option is only for Serial Port B.

<b>Base I/O</b>	<b>FORMAT:</b>	[option]
	<b>OPTIONS:</b>	3F8, 2F8 3E8, 2E8 These options are dependent on the IRQ, and vice versa.
	<b>NOTES:</b>	Recommended combinations include '3F8, IRQ4' and '2F8, IRQ3'.

<b>Interrupt</b>	<b>FORMAT:</b>	[option]
	<b>OPTIONS:</b>	IRQ4 IRQ3 These IRQs are paired with the Base I/O option.
	<b>NOTES:</b>	Recommended combinations include '3F8, IRQ4' and '2F8, IRQ3'.

<b>Parallel Port</b>	<b>FORMAT:</b>	[option]
	<b>OPTIONS:</b>	Disabled 'Disabled' turns off the port.
		Enabled 'Enabled' requires you to enter the base I/O address and the INT number.
		Auto 'Auto' makes the BIOS configure the port during POST.

<b>Mode</b>	<b>FORMAT:</b>	[option]
	<b>OPTIONS:</b>	Output only Standard one-way protocol for parallel devices.
		Bi-directional Two-way protocol for parallel devices.
		EPP Enhanced Parallel Port interface may provide higher bandwidth, if an EPP device is used.
		ECP Enhanced Capability Port interface may provide higher bandwidth, if an ECP device is used.

<b>Base I/O</b>	<b>FORMAT:</b>	[option]
	<b>OPTIONS:</b>	378 278 3BC These options appear when the parallel port is set to 'Enabled'.

<b>Interrupt</b>	<b>FORMAT:</b>	[option]
	<b>OPTIONS:</b>	IRQ5 IRQ7 These options appear when the parallel port is set to 'Enabled'.

(advanced setup, continued)

<b>DMA Channel</b>	<b>FORMAT:</b>	[option]	
	<b>OPTIONS:</b>	DMA1 DMA3	These options appear when parallel port is set to 'Enabled'.

<b>PCI Configuration</b>	Discussed on p. 42
--------------------------	--------------------

### 3.2-A. Chipset Configuration screen

Options related to the graphics interface can be altered through this screen.

<b>Graphics Aperture</b>	<b>FORMAT:</b>	[option]	
	<b>OPTIONS:</b>	32MB 64MB 128MB 256MB 512MB 1GB None	Sets the size of the memory area reserved for storage of graphics data structures used by the AGP.

<b>By Pass Mode</b>	<b>FORMAT:</b>	[option]	
	<b>OPTIONS:</b>	Disabled / Enabled	If set to Enabled, certain memory will be bypassed for performance.  Valid only if BOTH of the following are true:  1) System is single or dual processor and only P0 is present.  2) CPU clock divisor is 4:1 or greater.

<b>SERR Signal Condition</b>	<b>FORMAT:</b>	[option]	
	<b>OPTIONS:</b>	None	ERR signals not output under any condition.
		Single bit	ERR signal output for a single bit
		Multiple bits	ERR signal output for multiple bits
Both		ERR signal output for both instances.	

<b>ECC Config</b>	<b>FORMAT:</b>	[option]	
	<b>OPTIONS:</b>	Disabled	No error checking.
		EC (single bit)	Error checking & status report enabled. Data not corrected.
		ECC (multiple bits)	Error checking & status report enabled. Data is corrected.
ECC Scrub		Error checking & status report enabled. Data is corrected. Memory contents are corrected (scrubbed) after all reads with errors.	



### 3.2-B. Keyboard Configuration screen

Options related to the keyboard can be altered through this screen.

<b>NumLock</b>	<b>FORMAT:</b>	[option]	
	<b>OPTIONS:</b>	Auto	'Auto' will have the BIOS taking control of the NumLock key at POST.
		On	NumLock will be on after POST.
		Off	NumLock will remain off after POST.

<b>Keyboard auto-repeat rate</b>	<b>FORMAT:</b>	[option]	
	<b>OPTIONS:</b>	30/sec 26.7/sec 21.8/sec 18.5/sec 13.3/sec 10/sec 6/sec 2/sec	Sets speed at which keystrokes will be input into the system.

<b>Keyboard auto-repeat delay</b>	<b>FORMAT:</b>	[option]	
	<b>OPTIONS:</b>	1/4 sec 1/2 sec 3/4 sec 1 sec	Sets speed at which keystrokes will initially be delayed from being input into the system.

### 3.2-C. I/O Configuration screen

Options related to the I/O interface can be altered through this screen.

<b>PS/2 Mouse</b>	<b>FORMAT:</b>	[option]	
	<b>OPTIONS:</b>	AutoDetect	BIOS will auto-detect the presence of a PS/2 mouse.
		Disabled	Disable any installed PS/2 mouse device.
Enabled	Enable any installed PS/2 mouse device.		

<b>Floppy disk controller</b>	<b>FORMAT:</b>	[option]	
	<b>OPTIONS:</b>	Enabled	Onboard floppy controller is enabled.
		Disabled	Onboard floppy controller is disabled.
Auto	BIOS will detect the presence of a floppy controller.		

### 3.2-D. PCI Configuration screen

Options related to the PCI slots can be altered through this screen.

<b>PCI Device, Slot 1 (..2, 3, 4, 5)</b>	<b>FORMAT:</b>	<i>[option]</i>	
	<b>OPTIONS:</b>	<b>Option ROM Scan</b> (Enable or Disable)	Enables or disables device expansion ROM.
		<b>Enable Master</b> (Enable or Disable)	Enables selected device as a PCI bus master. Not every device can function as a master. Check your device documentation.
	<b>Latency Timer</b> (0020h, 0040h, 0060h, 0080h, 00C0h, Default)	Sets the bus master clock rate. A device that has high priority and high throughput may benefit from a greater value.	

### 3.2-E. PCI/PnP IRQ Exclusion screen

Options related to the PCI/PnP interrupts can be altered through this screen.

<b>IRQ3 [..4, 5, 7, 10, 11]</b>	<b>FORMAT:</b>	<i>[option]</i>	
	<b>OPTIONS:</b>	Available Reserved	Sets the availability of PCI IRQs to ISA devices. If set to 'Reserved', ISA devices are excluded from using the IRQ in question.

### 3.2-F. PCI/PnP UMB Exclusion screen

Options related to the upper memory buffer (UMB) can be altered through this screen.

<b>C800 - CBFF CC00 - CFFF D000 - D3FF D400 - D7FF D800 - DBFF DC00 - DFFF</b>	<b>FORMAT:</b>	<i>[option]</i>	
	<b>OPTIONS:</b>	Available Reserved	Sets the availability of the UMB address to ISA devices. If set to 'Reserved', ISA devices are excluded from using the UMB address in question.

### 3.3 Security Setup

Security options can be altered through this screen.

<b>Set Supervisor Password</b>	<b>FORMAT:</b>	[press the <b>[ENTER]</b> key]	
	<b>OPTIONS:</b>	[Enter]	Enter up to seven alphanumeric characters. You will be asked to confirm the password. In related systems, features will be accessible only by users who use the supervisor password.

<b>Password on boot</b>	<b>FORMAT:</b>	[option]	
	<b>OPTIONS:</b>	Disabled Enabled	Enabling requires a password on boot. Also requires prior setting of the supervisor password.  If the supervisor password is set and this option is disabled, the BIOS assumes the user is booting.

<b>Fixed disk boot sector</b>	<b>FORMAT:</b>	[option]	
	<b>OPTIONS:</b>	Normal	Disk is unrestricted.
		Write Protect	Write protect the boot sector on the fixed disk. Fixed disk will require a password to Fdisk or format the drive.

<b>Diskette Access</b>	<b>FORMAT:</b>	[option]	
	<b>OPTIONS:</b>	Disabled Enabled	Enabling this feature will password-restrict diskette drive access.

### 3.4 Power Setup

Power management options can be altered through this screen.

<b>ACPI Enabled</b>	<b>FORMAT:</b>	[option]	
	<b>OPTIONS:</b>	No Yes	ACPI can be enabled or disabled using this option.

<b>Power Savings</b>	<b>FORMAT:</b>	[option]	
	<b>OPTIONS:</b>	Customized	User must define the power saving values.
		Maximum Power Savings Maximum Performance	Each of these options will pre-define power saving values for the user.
Disabled		Turns off power management.	

(power setup, continued)

<b>Standby Timeout</b>	<b>FORMAT:</b>	[option]	
	<b>OPTIONS:</b>	Off 1 Minute 2 Minute 4 Minute 6 Minute 8 Minute 12 Minute 16 Minute	Inactivity period required to put system in Standby (partial power shutdown).
<b>Auto Suspend Timeout</b>	<b>FORMAT:</b>	[option]	
	<b>OPTIONS:</b>	Off 5 Minutes 10 Minutes 15 Minutes 20 Minutes 30 Minutes 40 Minutes 60 Minutes	Inactivity period required after Standby to Suspend (maximum power shutdown).
<b>Resume on modem ring</b>	<b>FORMAT:</b>	[option]	
	<b>OPTIONS:</b>	On Off	Wakes up system when an incoming call is detected by the modem.
<b>Resume on time</b>	<b>FORMAT:</b>	[option]	
	<b>OPTIONS:</b>	On Off	Wakes up system at preset time.
<b>Resume Time</b>	<b>FORMAT:</b>	[00:00:00]	
	<b>OPTIONS:</b>	hours minutes seconds	Preset time to wake system up.
<b>Resume Date</b>	<b>FORMAT:</b>	[00/00/0000]	
	<b>OPTIONS:</b>	month day year	Preset date to wake system up.

### 3.5 Boot Setup

Boot settings can be altered through this screen. All options are arranged by vertical priority.

(menu dependent on devices detected)	<b>FORMAT:</b>	[option]	
	<b>OPTIONS:</b>	(dependent on devices detected)	Each item detected as a removeable device, will be listed in this section.  As the user presses the '+' key, the item will move up in priority. The item at the top will take first priority, the second item takes next highest priority, and so on.

### 3.6 Exit Menu

Selecting "Exit" will display this menu.

Exit Saving Changes	<b>FORMAT:</b>	[option]	
	<b>OPTIONS:</b>	Yes No	Saves changes to CMOS and exits BIOS setup.

Exit Discarding Changes	<b>FORMAT:</b>	[option]	
	<b>OPTIONS:</b>	Yes No	Discard any changes and then exit BIOS setup.

Load Setup Defaults	<b>FORMAT:</b>	[option]	
	<b>OPTIONS:</b>	Yes No	Loads preset defaults from CMOS.

Discard Changes	<b>FORMAT:</b>	[option]	
	<b>OPTIONS:</b>	Yes No	Discards all changes.

Save Changes	<b>FORMAT:</b>	[option]	
	<b>OPTIONS:</b>	Yes No	Saves all changes.

## Chapter 4: System Resources

**Note:** If you experience problems with setting up your system, always check the following things in the following order:

### MEMORY, VIDEO, CPU

By checking these items, you will most likely find out what the problem might have been when setting up your system. For more information on troubleshooting, check the Tyan website at <http://www.tyan.com>

#### 4.1 Beep Codes

Fatal errors, which halt the boot process, are communicated through a series of audible beeps. For example, if the Phoenix BIOS POST can initialize the video but an error occurs, an error message will be displayed. If it cannot display video, it will convey a series of beeps.

If you hear one long beep followed by two short beeps, then a video problem has probably occurred and the BIOS is having difficulty initializing the video display. Any other beep sequences that may or may not occur are probably due to memory problems.

#### 4.2 Flash Utility

Every BIOS file is unique for the motherboard it was designed for. For Flash Utilities, BIOS downloads, and information on how to properly use the Flash Utility with your motherboard, you must check the Tyan website: <http://www.tyan.com>

#### NOTE:

Please be aware that by flashing your BIOS, you agree that in the event of a BIOS flash failure, you must contact your dealer for a replacement BIOS. There are no exceptions. Tyan does not have a policy of replacing BIOS chips directly with end users. In no event will Tyan be held responsible for damage done to the BIOS by the end user.

# Appendix I: SCSI Installation and LAN Information

## Introduction

The Adaptec 7899W enables you to connect up to 30 SCSI devices—such as very large arrays of high-performance HDDs, external storage subsystems, clustered configurations, Ultra160 hard disk drives, scanners, and CD-ROM drives.

The Adaptec 7899W can support up to two independent SCSI channels, each with a maximum throughput of 160 MBytes/sec. SCSI Channel A (marked\* either as “CH 1” or “CH A” on the board) has one internal connector. SCSI Channel B (marked\* either as “CH 2” or “CH B” on the board) has one internal connector.

You can connect Ultra160 and Ultra2 SCSI devices to the 68-pin Low Voltage Differential/Single-Ended (LVD/SE) connectors on both SCSI channels. Or you can operate the newer Ultra160 and Ultra2 devices at their maximum speed on Channel B while at the same time using legacy SCSI devices on Channel A.

This installation guide explains how to

- Set up SCSI devices
- Connect SCSI devices

## Support for Older SCSI Devices

We recommend that if you have single-ended Ultra SCSI and earlier SCSI devices you connect them to Channel A of the Adaptec 7899W SCSI and that you connect newer Ultra2 and Ultra160 SCSI devices to Channel B. This allows the Adaptec 7899W to support newer Ultra160 and Ultra2 SCSI devices at speeds up to 160 MBytes/sec while at the same time supporting Ultra (legacy) devices at speeds up to 40 MBytes/sec. It also allows you to use longer cable lengths for the newer SCSI devices.

### NOTE:

If you connect Wide Ultra/Ultra SCSI devices to the same SCSI channel as Ultra160 and Ultra2 SCSI devices, the data transfer rate for the Ultra160 and Ultra2 SCSI devices will drop to Ultra SCSI performance levels. To achieve maximum data transfer rates for the newer SCSI devices, be sure to connect them on their own SCSI channel.

## Setting up SCSI devices

There are several things you may need to do to your SCSI devices before you connect them to the Adaptec 7899W SCSI:

- Check the SCSI IDs
- Set the termination
- Connect the power cables

\* subject to change without notice

Since setup can vary from device to device, always refer to the device's documentation for specific instructions. Below are some guidelines for setting SCSI IDs and termination on your devices.

### Check the SCSI IDs

The Adaptec 7899W and each device you connect to it must have a unique SCSI ID number ranging from 0 to 15 on each channel. No two devices on the same SCSI channel can have the same SCSI ID.

The Adaptec 7899W is preset to ID 7 for each channel and should not be changed. If you boot from a SCSI hard disk, make sure the hard disk SCSI ID is set to 0. (Most SCSI hard disks are preset to SCSI ID 0 at the factory.) The SCSI IDs for internal devices are usually set with jumpers; SCSI IDs for external devices are usually set with a switch on the back of the device.

### Terminate the Ends

To ensure reliable communication on the SCSI bus, the device at the end of each cable, or the end of the cable itself, must have a terminator installed (or enabled). Terminators must be removed, or termination must be disabled, on devices between the ends of each cable.

#### NOTE:

When connecting Ultra160 or Ultra2 SCSI devices, the SCSI bus must be terminated either on the end of the cable (with a permanent terminator) or with a separate terminating connector. Ultra SCSI and earlier single-ended devices can terminate the bus directly from the device. If you use an Ultra SCSI terminator on an LVD Ultra160 and Ultra2 SCSI bus you will force the bus to Single-ended mode, limiting the speed and cable distance. For this reason be sure that you have the necessary Ultra160 or Ultra2 cable or terminator before installing the Ultra160 SCSI devices.

### Connecting SCSI Devices

You can connect a total of 30 SCSI devices to the Adaptec 7899W, with up to 15 devices on each SCSI channel. Before connecting devices, be sure to review **Setting up SCSI Devices** on p. 47.

### Connecting Internal Ultra160 and Ultra2 Devices

A special 68-pin internal LVD cable is needed to connect internal Ultra160 or Ultra2 SCSI devices. If your cables are not marked, you can identify most LVD cables as having twisted pairs of the flat ribbon cable between the device connectors. Some cables are laminated so that they lay flat. Internal LVD cables usually have a terminator built into the end of the cable.

The Adaptec 7899W has two separate Ultra160 SCSI channels, as shown on the board map on p. 11. Each channel has an internal LVD/SE connector to which you can connect internal SCSI devices. Follow these steps to connect your internal Ultra160 and Ultra2 devices:



**NOTE:**

We recommend that you keep your Ultra160 and Ultra2 SCSI devices on a separate SCSI channel from your Ultra SCSI devices. This allows the newer Ultra160 and Ultra2 SCSI devices to transfer data at their maximum speed.

**Step 1** Locate a 68-pin internal LVD SCSI cable, which may have either twisted wires or flat wires, as shown here.

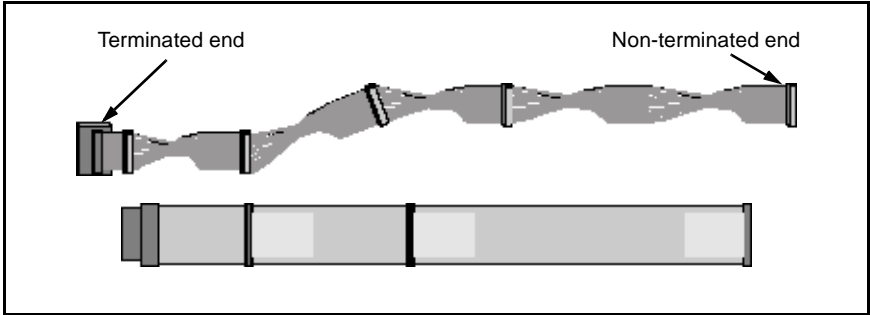

**Step 2** Plug the non-terminated end of the cable(s) to the LVD/SE SCSI connector(s) (shown below).

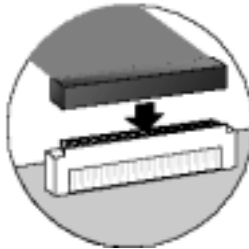

**Step 3** Plug the internal Ultra160 and Ultra2 SCSI devices to the other cable connectors, starting with the connector at the terminated end of the cable (note: example installation below may not identically represent installation).

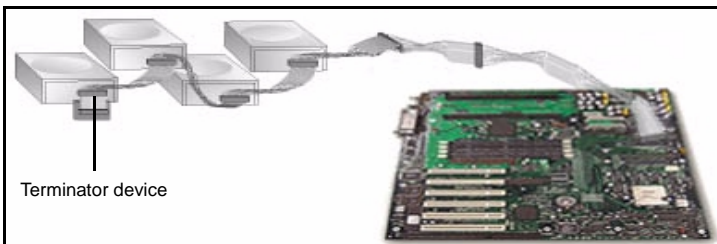

**NOTE:**

Internal Ultra160 SCSI peripherals come from the factory without termination. Proper termination is provided by the built-in terminator at the end of the Ultra160 internal SCSI cable.

**Step 4** Connect a power cable from your computer's internal power supply to each internal SCSI device.

### Connecting Wide SCSI Devices

You can connect Wide SCSI devices to the internal LVD/SE connectors. If you do this, we recommend that you connect them to the SCSI Channel A LVD/SE connector and that you connect all Ultra160 and Ultra2 devices to the SCSI Channel B connector. Follow these steps to connect Wide SCSI devices:

**Step 1** Locate a 68-pin internal Wide SCSI cable.



**Step 2** Plug one end of the cable to one of the SCSI connectors.



**Step 3** Plug the other end of the cable to a **terminated** Ultra/Fast Wide SCSI device.

**Step 4** If you have other Ultra/Fast Wide SCSI devices, attach them to the connectors between the two ends of the cable. Be sure these other devices are **unterminated**.

**Step 5** Connect a power cable from your computer's internal power supply to each internal device.

### More information about termination

The last SCSI device on the end of each SCSI bus cable must be terminated, and termination must be **disabled** for all other devices in the middle of the cables. Ultra160 and Ultra2 SCSI devices are automatically un-terminated, but Ultra SCSI and Fast/Wide SCSI devices do have termination that you must check. For more information, refer to the documentation for each SCSI device. If you are using external Ultra2 or Ultra160 devices, be sure to use an LVD terminator to terminate the last device in the chain. If you use a single-ended, active terminator (sometimes called an Ultra terminator) the SCSI devices will not operate at their maximum speed.

If you have any problems while setting up SCSI devices, check the following items first:

- Are all SCSI devices powered on?
- Are all SCSI cables and power cables properly connected?
- Does each device on each SCSI bus have a unique SCSI ID?
- Does the total SCSI cable length exceed the maximum allowable length? (See table below.)
- Is the SCSI bus properly terminated?

If you are still unable to resolve a problem, contact your vendor for help.

### Maximum Cable Lengths

Maximum Cable Length	Data Transfer Rate	Maximum Devices Supported
25 m (82.0 ft)	Ultra160 SCSI (160 MBytes/sec) and Ultra2 SCSI (80 MBytes/sec)	1
12 m (39.4 ft)	Ultra160 SCSI (160 MBytes/sec)* and Ultra2 SCSI (80 MBytes/sec)	15
3 m (9.8 ft)	Fast Wide SCSI (20 MBytes/sec)	15
3 m (9.8 ft)	Fast SCSI (10 MBytes/sec)	7
3 m (9.8 ft)	Ultra SCSI (40 MBytes/sec for 16-bit, 20 MBytes/sec for 8-bit)	4
1.5 m (4.9 ft)	Ultra SCSI (40 MBytes/sec for 16-bit, 20 MBytes/sec for 8-bit)	5-7**

\* Mixing Fast/Ultra devices with Ultra160 and Ultra2 SCSI devices causes the entire SCSI bus to default to Ultra SCSI speeds and cable length requirements.

\*\* Ultra SCSI data transfer rates do not currently support more than seven devices connected to the SCSI card.

## Configuring the Adaptec 7899W SCSI with SCSISelect

SCSISelect enables you to change SCSI settings without opening the computer or handling the card. SCSISelect also enables you to low-level format or verify the disk media of your SCSI hard disk drives. The following table lists the available and default settings for each SCSISelect option. The settings that are marked as "Auto-sync" are automatically synchronized for both SCSI channels—for example, if you change the Boot Channel option to **B First** on Channel A, the change will apply to Channel B as well. All other options can be set separately for each of the two SCSI channels.

The default settings are appropriate for most systems and should not be changed. Run SCSISelect if you need to change or view current settings, or if you need to use the SCSI disk utilities.

SCSISelect Options	Available Settings	Default Setting
<b>SCSI Bus Interface Definitions:</b>		
Host Adapter SCSI ID	0-15	7
SCSI Parity Checking	Enabled Disabled	Enabled
Host Adapter SCSI Termination: Ch. A	Automatic Low On/High On Low Off/High Off Low Off/High On	Automatic
Ch. B	Automatic, Enabled, Disabled	Automatic
<b>Boot Device Options:</b>		
Boot Channel [ <i>Auto-sync</i> ]	A First, B First	A First
Boot SCSI ID	0-15	0
Boot LUN Number <sup>a</sup>	0-7	0
<b>SCSI Device Configuration:</b>		
Sync Transfer Rate (MBytes/sec)	160, 80.0, 53.4, 40.0, 32.0, 26.8, 20.0, 16.0, 13.4, 10.0, ASYN	160
Initiate Wide Negotiation	Yes, No	Yes (Enabled)
Enable Disconnection	Yes, No	Yes (Enabled)
Send Start Unit Command	Yes, No	Yes (Enabled)
Enable Write Back Cache <sup>b</sup>	Yes, No, N/C (No Change)	N/C (No Change)
BIOS Multiple LUN Support <sup>b</sup>	Yes, No	No (Disabled)
Include in BIOS Scan <sup>b</sup>	Yes, No	Yes (Enabled)
<b>Advanced Configuration Options:</b>		
Reset SCSI Bus at IC Initialization	Enabled, Disabled	Enabled
Display <Ctrl> <A> Messages during BIOS Initialization [ <i>Auto-sync</i> ]	Enabled, Disabled	Enabled
Extended BIOS Translation for DOS Drives > 1 GByte	Enabled, Disabled	Enabled
Verbose/Silent Mode [ <i>Auto-sync</i> ]	Verbose, Silent	Verbose

SCSISelect Options	Available Settings	Default Setting
Host Adapter BIOS [ <i>Auto-sync</i> ]	Enabled Disabled: Scan Bus Disabled: Not Scan	Enabled
Domain Validation <sup>b</sup> [ <i>Auto-sync</i> ]	Enabled, Disabled	Enabled
Support Removable Disks Under BIOS as Fixed Disks <sup>b</sup>	Disabled, Boot Only, All Disks	Disabled
BIOS Support for Bootable CD-ROM <sup>b</sup>	Enabled, Disabled	Enabled
BIOS Support for Int 13 Extensions <sup>b</sup>	Enabled, Disabled	Enabled

a. Setting is valid only if Multiple LUN Support is enabled.

b. Settings are valid only if host adapter BIOS is enabled.

### Follow these steps to start SCSISelect:

Turn on or restart your system.

During the startup process, pay careful attention to the messages that appear on your screen. When the following message appears on your screen, press the **[Ctrl]+[A]** keys simultaneously (this message appears for only a few seconds):

Press <Ctrl><A> for SCSISelect (TM) Utility!

Select SCSI Channel **A** or **B**. Most SCSISelect options can be set separately for each SCSI channel.

From the menu that appears, use the arrow keys to move the cursor to the option you want to select, then press **[Enter]**.

---

Note: If you have difficulty viewing the display, press **F5** to toggle between color and monochrome modes. (This feature may not work on some monitors.)

---

### Exiting SCSISelect

Follow these steps to exit SCSISelect:

Press **Esc** until a message prompts you to exit (if you changed any settings, you are prompted to save the changes before you exit).

At the prompt, select **Yes** to exit, then press any key to reboot the computer. Any changes you made in SCSISelect take effect after the computer boots.

## Using SCSISelect Settings

To select an option, use the arrow keys to move the cursor to the option, then press **[Enter]**.

In some cases, selecting an option displays another menu. You can return to the previous menu at any time by pressing **[Esc]**.

To restore the original SCSISelect default values, press **[F6]** from the main SCSISelect screen.

### SCSI Bus Interface Definitions

- **Host Adapter SCSI ID**—(Default: 7) Sets the SCSI ID for the SCSI controller. The Adaptec 7899W is set at 7, which gives it the highest priority on the SCSI bus. We recommend that you do not change this setting.
- **SCSI Parity Checking**—(Default: *Enabled*) When set to **Enabled**, verifies the accuracy of data transfer on the SCSI bus. Leave this setting enabled unless any SCSI device connected to the Adaptec 7899W does not support SCSI parity.
- **Host Adapter SCSI Termination**—(Default: *Automatic*) Determines the termination setting for the SCSI controller. The default setting is *Automatic*, which allows the SCSI controller to adjust the termination as needed depending on the configuration of the connected SCSI devices. We recommend that you do not change this setting.

### Boot Device Options

- **Boot Channel**—(Default: *A First*) Specifies which of the two SCSI channels the boot device is connected to (if the computer boots from a SCSI device). If you change this setting, the change automatically applies to both SCSI channels.
- **Boot SCSI ID**—(Default: 0) Specifies the SCSI ID of your boot device. We recommend that you do not change the default setting.
- **Boot LUN Number**—(Default: 0) Specifies which LUN (Logical Unit Number) to boot from on your boot device. This setting is not valid unless Multiple LUN Support is Enabled

### SCSI Device Configuration Options

SCSI Device Configuration options can be set individually for each connected SCSI device.

---

Note: To configure settings for a SCSI device, you must know its SCSI ID.

---

- **Sync Transfer Rate**—(Default: 160) Determines the maximum synchronous data transfer rate that the SCSI controller supports. We recommend that you leave the maximum (default) value of 160 MBytes/sec.
- **Initiate Wide Negotiation**—(Default: Yes) When set to **Yes**, the SCSI controller attempts 16-bit data transfer (wide negotiation). When set to **No**, the SCSI controller uses 8-bit data transfer unless the SCSI device requests wide negotiation.

Note: Set Initiate Wide Negotiation to **No** if you are using an 8-bit SCSI device that hangs or exhibits other performance problems with 16-bit data transfer rate enabled.

- **Enable Disconnection**—(Default: Yes) When set to **Yes**, allows the SCSI device to disconnect from the SCSI bus. Leave the setting at **Yes** if two or more SCSI devices are connected to the SCSI chip. If only one SCSI device is connected, changing the setting to **No** results in slightly better performance.
- **Send Start Unit Command**—(Default: Yes) When set to **Yes**, the Start Unit Command is sent to the SCSI device at bootup.

The following three options have no effect if the SCSI BIOS is disabled. (The SCSI BIOS is normally enabled by default.)

- **Enable Write Back Cache**—(Default: *N/C*) Can be used to enable or disable the write-back cache on SCSI disk drives connected to the host adapter. Leave this option at its default setting of *N/C* (no change), which usually allows for optimum drive performance.
- **BIOS Multiple LUN Support**—(Default: *No*) Leave this setting at **No** if the device does not have multiple Logical Unit Numbers (LUNs). When set to **Yes**, the SCSI controller BIOS provides boot support for a SCSI device with multiple LUNs (for example, a CD “juke box” device in which multiple CDs can be accessed simultaneously).
- **Include in BIOS Scan**—(Default: *Yes*) When set to **Yes**, the SCSI controller BIOS includes the device as part of its BIOS scan at bootup.

### Advanced Configuration Options

---

Note: *Do not change the Advanced Configuration Options unless absolutely necessary.*

---

- **Reset SCSI Bus at IC Initialization**—(Default: *Enabled*) When set to **Enabled**, the SCSI controller generates a SCSI bus reset during its power-on initialization and after a hard reset.
- **Display <Ctrl> <A> Messages during BIOS Initialization**—(Default: *Enabled*) When set to **Enabled**, the SCSI BIOS displays the Press <Ctrl> <A> for SCSISelect (TM) Utility! message on your screen during system bootup. If this setting is disabled, you can still invoke the SCSISelect utility by pressing <Ctrl> <A> after the SCSI BIOS banner appears. If you change this setting, the change automatically applies to both SCSI channels.
- **Extended BIOS Translation for DOS Drives > 1 GByte**—(Default: *Enabled*) When set to **Enabled**, provides an extended translation scheme for SCSI hard disks with capacities greater than 1 GByte. This setting is necessary only for MS-DOS 5.0 or above; it is not required for other operating systems.

Caution: Changing the translation scheme destroys all data on the drive. Be sure to back up your disk drives before changing the translation scheme.

Use the MS-DOS Fdisk command to partition a disk larger than 1 GByte controlled by the SCSI BIOS, when using DOS.

- **Verbose/Silent Mode**—(Default: *Verbose*) When set to **Verbose**, the SCSI BIOS displays the host adapter model on the screen during system buildup. When set to **Silent**, the message will not be displayed during bootup. If you change this setting, the change automatically applies to both SCSI channels.
- **Host Adapter BIOS (Configuration Utility Reserves BIOS Space)**—(Default: *Enabled*) Enables or disables the SCSI BIOS. If you change this setting, the change automatically applies to both SCSI channels.
  - Leave at **Enabled** to allow the SCSI BIOS to scan and initialize all SCSI devices at initial bootup.
  - Set to **Disabled: Not scan** if the devices on the SCSI bus (e.g. CD-ROM drives) are controlled by software drivers and do not need the BIOS, and you do not want the BIOS to scan the SCSI bus.
  - Set to **Disabled: Scan Bus** if you don't need the BIOS, but want to scan SCSI devices on the bus.

The following four options on the next page have no effect when the SCSI BIOS is disabled. (The SCSI BIOS is normally enabled by default.)

- **Domain Validation**—(Default: *Enabled*) Determines what kinds of SCSI devices are connected and reduces data transfer speed if it detects older legacy SCSI devices. Displays the resulting data transfer rate. If you change this setting, the change automatically applies to both SCSI channels.
- **Support Removable Disks Under BIOS as Fixed Disks**—(Default: *Disabled*) Determines which removable-media drives are supported by the SCSI controller BIOS. The options are as follows:
  - **Disabled**— No removable media drives are treated as hard disk drives. Software drivers are then required from the vendor, because the drives themselves are not controlled at all by the BIOS.

**NOTE:** *You may lose data* if you remove a removable-media cartridge from a SCSI drive controlled by the SCSI controller BIOS while the drive is on. If you want to be able to remove the media while the drive is on, install the removable-media software driver and set Support Removable Disks Under BIOS as Fixed Disks to **Disabled**.

  - **Boot Only**—Only the removable media drive designated as the boot device is treated as an HDD
  - **All Disks**—All removable media drives supported by the BIOS are treated as HDDs
  - **BIOS Support for Bootable CD-ROMs**—(Default: *Enabled*) When set to **Enabled** the SCSI controller BIOS allows the computer to boot from a CD-ROM drive.
  - **BIOS Support for Int 13 Extensions**—(Default: *Enabled*) When set to **Enabled**, the SCSI controller BIOS supports Int 13h extensions as required by Plug-and-Play. The setting can be either enabled or disabled if your system is not Plug-and-Play

## LAN Information

Your motherboard has (2) onboard 3Com 3C920 LAN controllers. LAN capabilities including 10/100 MBits/s transfer speed. For more information regarding the onboard LAN controllers, check the 3Com website: <http://www.3com.com>

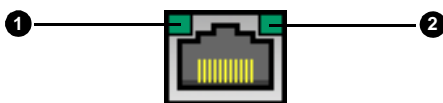

Below are some explanations of what the LEDs mean, and how they display the LAN's status.

LAN Status	LED (1) - Green/Orange Light	LED (2) - Yellow Light
Good connection @ 10 Mbps	LED (1) is GREEN	OFF
Good connection @ 100 Mbps	LED (1) is ORANGE	OFF
No connection	OFF	OFF
Data being transferred	Green (10Mbps) or Orange (100Mbps)	LED is blinking



## Appendix II: Glossary

**ACPI** (Advanced Configuration and Power Interface): a power management specification that allows the operating system to control the amount of power distributed to the computer's devices. Devices not in use can be turned off, reducing unnecessary power expenditure.

**AGP** (Accelerated Graphics Port): a PCI-based interface which was designed specifically for demands of 3D graphics applications. The 32-bit AGP channel directly links the graphics controller to the main memory. While the channel runs at only 66 MHz, it supports data transmission during both the rising and falling ends of the clock cycle, yielding an effective speed of 133 MHz.

**ATAPI** (AT Attachment Packet Interface): also known as IDE or ATA; a drive implementation that includes the disk controller on the device itself. It allows CD-ROMs and tape drives to be configured as master or slave devices, just like HDDs.

**ATX**: the form factor designed to replace the AT form factor. It improves on the AT design by rotating the board 90 degrees, so that the IDE connectors are closer to the drive bays, and the CPU is closer to the power supply and cooling fan. The keyboard, mouse, USB, serial, and parallel ports are built-in.

**Bandwidth**: refers to carrying capacity. The greater the bandwidth, the more data the bus, phone line, or other electrical path, can carry. Greater bandwidth, then, also results in greater speed.

**BBS** (BIOS Boot Specification): is a feature within the BIOS that creates, prioritizes, and maintains a list of all Initial Program Load (IPL) devices, and then stores that list in NVRAM. IPL devices have the ability to load and execute an OS, as well as provide the ability to return to the BIOS if the OS load process fails for some reason. At that point, the next IPL device is called upon to attempt loading of the OS.

**BIOS** (Basic Input/Output System): the program that resides in the ROM chip, and provides the basic instructions for controlling your computer's hardware. Both the operating system and application software use BIOS routines to ensure compatibility.

**Buffer**: a portion of RAM which is used to temporarily store data, usually from an application, though it is also used when printing, and in most keyboard drivers. The CPU can manipulate data in a buffer before copying it, all at once, to a disk drive. While this improves system performance --- reading to or writing from a disk drive a single time is much faster than doing so repeatedly --- there is also the possibility of losing your data should the system crash. Information stored in a buffer is temporarily stored, not permanently saved.

**Bus**: a data pathway. The term is used especially to refer to the connection between the processor and system memory, and between the processor and PCI or ISA local buses.

**Bus mastering:** allows peripheral devices and IDEs to access the system memory without going through the CPU (similar to DMA channels).

**Cache:** a temporary storage area for data that will be needed often by an application. Using a cache lowers data access times, since the needed information is stored in the SRAM instead of in the slow DRAM. Note that the cache is also much smaller than your regular memory: a typical cache size is 512KB, while you may have as much as 4GB of regular memory.

**Cache size:** refers to the physical size of the cache onboard. This should not be confused with the cacheable area, which is the total amount of memory which can be scanned by the system in search of data to put into the cache. A typical setup would be a cache size of 512KB, and a cacheable area of 512MB. In this case, up to 512KB of the main memory onboard is capable of being cached. However, only 512KB of this memory will be in the cache at any given moment. Any main memory above 512MB could never be cached.

**Closed and open jumpers:** jumpers and jumper pins are active when they are “on” or “closed”, and inactive when they are “off” or “open”.

**CMOS** (Complementary Metal-Oxide Semiconductors): chips that hold the basic startup information for the BIOS.

**COM port:** another name for the serial port, which is called as such because it transmits the eight bits of a byte of data along one wire, and receives data on another single wire (that is, the data is transmitted in serial form, one bit after another). Parallel ports transmit the bits of a byte on eight different wires at the same time (that is, in parallel form, eight bits at the same time).

**DDR** (Double Data Rate): is a technology designed to double the clock speed of the memory. It activates output on both the rising and falling edge of the system clock rather than on just the rising edge, potentially doubling output.

**DIMM** (Dual In-line Memory Module): faster and more capacious form of RAM than SIMMs, and do not need to be installed in pairs.

**DIMM bank:** sometimes called DIMM sockets, because the physical slot and the logical unit are the same. That is, one DIMM module fits into one DIMM socket, which is capable of acting as a memory bank.

**DMA** (Direct Memory Access): channels that are similar to IRQs. DMA channels allow hardware devices (like soundcards or keyboards) to access the main memory without involving the CPU. This frees up CPU resources for other tasks. As with IRQs, it is vital that you do not double up devices on a single line. Plug-n-Play devices will take care of this for you.

**Doze mode:** in this mode, only the CPU's speed is slowed.

**DRAM** (Dynamic RAM): widely available, very affordable form of RAM which has the unfortunate tendency to lose data if it is not recharged regularly (every few milliseconds). This refresh requirement makes DRAM three to ten times slower than non-recharged RAM such as SRAM.

**ECC** (Error Correction Code or Error Checking and Correcting): allows data to be checked for errors during run-time. Errors can subsequently be corrected at the same time that they're found.

**EEPROM** (Electrically Erasable Programmable ROM): also called Flash BIOS, is a ROM chip which can, unlike normal ROM, be updated. This allows you to keep up with changes in the BIOS programs without having to buy a new chip. Tyan's BIOS updates can be found at <http://www.tyan.com>

**ESCD** (Extended System Configuration Data): a format for storing information about Plug-n-Play devices in the system BIOS. This information helps properly configure the system each time it boots.

**Fault-tolerance**: a term describing a system where one component can quickly be replaced without causing a loss of service, such as in a **RAID** system.

**Firmware**: low-level software that controls the system hardware.

**Form factor**: an industry term for the size, shape, power supply type, and external connector type of the Personal Computer Board (PCB) or motherboard. The standard form factors are the AT and ATX, although Tyan also makes some Baby-AT and ATX Footprint boards.

**Global timer**: onboard hardware timer, such as the Real-Time Clock (RTC).

**Handshaking**: a form of encryption. One system, typically the server, sends an encryption scheme to another agent, typically a client. Thus, the client's data is protected during transmittal to the server.

**HDD**: stands for Hard Disk Drive, a type of fixed drive.

**H-SYNC**: controls the horizontal synchronization/properties of the monitor.

**IC** (Integrated Circuit): the formal name for the computer chip.

**IDE** (Integrated Device/Drive Electronics): a simple, self-contained HDD interface. It can handle drives up to 8.4 GB in size. Almost all IDEs sold now are in fact Enhanced IDEs (EIDEs), with maximum capacity determined by the hardware controller.

**IDE INT** (IDE Interrupt): a hardware interrupt signal that goes to the IDE.

**I/O** (Input/Output): the connection between your computer and another piece of hardware (mouse, keyboard, etc.)

**Initial Program Load (IPL):** a feature built into BBS-compliant devices, describing those devices as capable of loading and executing an OS, as well as being able to provide control back to the BIOS if the loading attempt fails.

**IPL:** see **Initial Program Load**.

**IRQ** (Interrupt Request): an electronic request that runs from a hardware device to the CPU. The interrupt controller assigns priorities to incoming requests and delivers them to the CPU. It is important that there is only one device hooked up to each IRQ line; doubling up devices on IRQ lines can lock up your system. Plug-n-Play operating systems can take care of these details for you.

**ISA** (Industry Standard Architecture): a slower 8- or 16-bit bus (data pathway).

**Latency:** the amount of time that one part of a system spends waiting for another part to catch up. This is most common when the system sends data out to a peripheral device, and it waiting for the peripheral to send some data back (peripherals tend to be slower than onboard system components).

**Mirroring:** see **RAID**.

**NVRAM:** ROM and EEPROM are both examples of Non-Volatile RAM, memory that holds its data without power. DRAM, in contrast, is volatile.

**OEMs** (Original Equipment Manufacturers): Compaq or IBM package other companies' motherboards and hardware inside their case and sell them.

**Parallel port:** transmits the bits of a byte on eight different wires at the same time (that is, in parallel form, eight bits at the same time).

**PCI** (Peripheral Component Interconnect): a 32 or 64-bit local bus (data pathway) which is faster than the ISA bus. Local buses are those which operate within a single system (as opposed to a network bus, which connects multiple systems).

**PCI PIO** (PCI Programmable Input/Output) modes: the data transfer modes used by IDE drives. These modes use the CPU for data transfer (in contrast, DMA channels do not). PCI refers to the type of bus used by these modes to communicate with the CPU.

**PCI-to-PCI bridge:** allows you to connect multiple PCI devices onto one PCI slot.

**Pipeline burst SRAM:** a fast secondary cache. It is used as a secondary cache because SRAM is slower than SDRAM, but usually larger. Data is cached first to the faster primary cache, and then, when the primary cache is full, to the slower secondary cache.

**Pipelining:** improves system performance by allowing the CPU to begin executing a second instruction before the first is completed. A pipeline can be likened to an assembly line, with a given part of the pipeline repeatedly executing a set part of an operation on a series of instructions.

**PM timers (Power Management timers):** software timers that count down the number of seconds or minutes until the system times out and enters sleep, suspend, or doze mode.

**PnP (Plug-n-Play):** a design standard that has become ascendant in the industry. Plug-n-Play devices require little set-up to use. Novice end users can simply plug them into a computer that is running on a Plug-n-Play aware operating system (such as Windows 98), and go to work. Devices and operating systems that are not Plug-n-Play require you to reconfigure your system each time you add or change any part of your hardware.

**PXE (Preboot Execution Environment):** one of four components that together make up the Wired for Management 2.0 baseline specification. PXE was designed to define a standard set of preboot protocol services within a client, towards the goal of allowing networked-based booting to boot using industry standard protocols.

**RAID (Redundant Array of Independent Disks):** a way for the same data to be stored in different places on many hard drives. By using this method, the data is stored redundantly, also the multiple hard drives will appear as a single drive to the operating system. RAID level 0 is known as striping, where data is striped (or overlapped) across multiple hard drives, but offers no fault-tolerance. RAID level 1 is known as mirroring, which stores the data within at least two hard drives, but does not stripe. RAID level 1 also allows for faster access time and fault-tolerance, since either hard drive can be read at the same time. RAID level 0+1 is both striping and mirroring, providing fault-tolerance, striping, and faster access all at the same time.

**RAM (Random Access Memory):** technically refers to a type of memory where any byte can be accessed without touching the adjacent data, is often used to refer to the system's main memory. This memory is available to any program running on the computer.

**ROM (Read-Only Memory):** a storage chip which contains the BIOS; the basic instructions required to boot the computer and start up the operating system.

**SDRAM (Synchronous Dynamic RAM):** called as such because it can keep two sets of memory addresses open simultaneously. By transferring data alternately from one set of addresses and then the other, SDRAM cuts down on the delays associated with non-synchronous RAM, which must close one address bank before opening the next.

**Serial port:** called as such because it transmits the eight bits of a byte of data along one wire, and receives data on another single wire (that is, the data is transmitted in serial form, one bit after another).

**SIMM** (Single In-line Memory Module): formerly the most common form of RAM for motherboards. They must be installed in pairs, and do not have the carrying capacity or the speed of DIMMs.

**Sleep/Suspend mode:** in this mode, all devices except the CPU shut down.

**SRAM** (Static RAM): unlike DRAM, this type of RAM does not need to be refreshed in order to prevent data loss. Thus, it is faster, and more expensive.

**Standby mode:** in this mode, the video and fixed disk drive (usually the HDD) shuts down; all other devices continue to operate normally.

**Striping:** see RAID.

**UltraDMA/33/66/100:** a fast version of the old DMA channel. UltraDMA is also called UltraATA. Without the proper UltraDMA controller, your system cannot take advantage of the higher data transmission rates of the new UltraDMA/UltraATA HDDs.

**USB** (Universal Serial Bus): a versatile port. This one port type can function as a serial, parallel, mouse, keyboard, or joystick port. It is fast enough to support video transfer, and is capable of supporting up to 127 daisy-chained peripheral devices.

**VGA** (Video Graphics Array): the PC video display standard.

**V-SYNC:** controls the vertical properties of the monitor.

**ZIF socket** (Zero Insertion Force socket): these sockets make it possible to insert CPUs without damaging the sensitive CPU pins. The CPU is lightly placed in an open ZIF socket, and the metal level is pulled down. This shifts the processor over and down, guiding it into place on the board.

## Technical Support

If a problem arises with your system, you should turn to your dealer for help first. Your system has most likely been configured by them, and they should have the best idea of what hardware and software your system contains. Hence, they should be of the most assistance. Furthermore, if you purchased your system from a dealer near you, you can actually bring your system to them to have it serviced, instead of attempting to do so yourself (which can have expensive consequences).

### Help Resources:

1. See the FAQ and beep codes section of this manual.
2. See the Tyan website for FAQ, bulletins, driver updates, and other information: <http://www.tyan.com>
3. Contact your dealer for help **BEFORE** calling Tyan.
4. Check the Tyan user group: [alt.comp.periphs.mainboard.tyan](mailto:alt.comp.periphs.mainboard.tyan)

## Returning Merchandise for Service

During the warranty period, contact your distributor or system vendor **FIRST** for any product problems. This warranty only covers normal customer use and does not cover damages incurred during shipping or failure due to the alteration, misuse, abuse, or improper maintenance of products.

**NOTE: A receipt or copy of your invoice marked with the date of purchase is required before any warranty service can be rendered. You may obtain service by calling the manufacturer for a Return Merchandise Authorization (RMA) number. The RMA number should be prominently displayed on the outside of the shipping carton and the package should be mailed prepaid. Tyan will pay to have the board shipped back to you.**



### Notice for the USA

Compliance Information Statement (Declaration of Conformity Procedure) DoC  
FCC Part 15: This device complies with Part 15 of the FCC Rules.

Operation is subject to the following conditions:

- 1) this device may not cause harmful interference, and
- 2) this device must accept any interference received including interference that may cause undesired operation. If this equipment does cause harmful interference to radio or television reception, which can be determined by turning the equipment off and on, the user is encouraged to try one or more of the following measures:
  - Reorient or relocate the receiving antenna.
  - Increase the separation between the equipment and receiver.
  - Plug the equipment into an outlet on a circuit different from that of the receiver.
  - Consult the dealer or an experienced radio/television technician for help.

### Notice for Canada

This apparatus complies with the Class B limits for radio interference as specified in the Canadian Department of Communications Radio Interference Regulations. (Cet appareil est conforme aux normes de Classe B d'interférence radio tel que spécifié par le Ministère Canadien des Communications dans les règlements d'interférence radio.)



### Notice for Europe (CE Mark)

This product is in conformity with the Council Directive 89/336/EEC, 92/31/EEC (EMC).

**CAUTION:** Lithium battery included with this board. Do not puncture, mutilate, or dispose of battery in fire. Danger of explosion if battery is incorrectly replaced. Replace only with the same or equivalent type recommended by manufacturer. Dispose of used battery according to manufacturer instructions and in accordance with your local regulations.